

Work Storage

Vicinity™



HON®

Smart now. Smarter later.



The solution for all that “stuff” is right in your





Adaptive.
Organized.
Refined.

Vicinity.

Vicinity is a new kind of storage system: It adapts more readily to different environments and workstyles. Empowers users to organize and stage their work in addition to storing all their "stuff." Offers a fresh, refined look that will complement any office design.

Vicinity. It's storage that works.



Sheer Mesh laminate, Lucy Snowdrop tackboard fabric, Radius pulls and Muslin finish.

Stores anything, goes anywhere, supports any workstyle.



Multiple Personality.

Vicinity can perform multiple roles within an organization. Here, it promotes collaboration – enhancing group access to frequently used reference materials.



Natural Maple laminate, Daybreak Bisque tackboard fabric, Arch pulls and Muslin finish. Perpetual® Lounge Chairs with Bound Chestnut and Lariat Chocolate upholstery, and Titanium finish.





Adapts to any setting.

Use Vicinity throughout an office to simplify planning and inventory. In panel-based environments, Vicinity reduces workstation footprints by providing compatible, versatile central storage. Files, cabinets, shelves and other components can be combined in one-of-a-kind configurations that meet unique needs. It's also easy to add and reconfigure components as needs change.



One to Grow On.

Vicinity's "expandability" keeps pace with growing businesses – it's an investment that can be leveraged for years. Bourbon Cherry laminate, Arch pulls and Champagne Metallic finish. Resolution® Low-Back Chairs and Guest Chairs with Impact Serene upholstery and Titanium finish. Initiate® panels with Lucy Dusk fabric and Champagne Metallic finish.

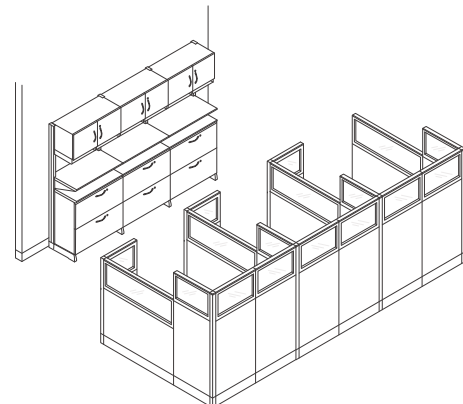



Adapts to any purpose.



Vicinity's column-based design and versatile kit of parts make it easy to customize a wide range of functional solutions: public and private environments, task-oriented spaces, supply-intensive areas and more. Components attach easily and securely to columns – and they're just as easily reconfigured to meet evolving demands.



Show Your Stuff.

Open cabinets and display shelves showcase work and personal items. Components can be adjusted up and down columns in 1-1/8" increments, making Vicinity exceptionally flexible and ADA friendly.

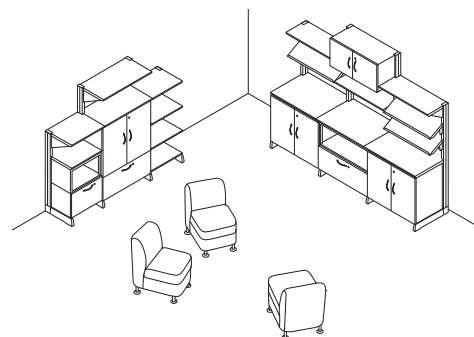



Adapts to any workstyle.

Because many people “store” near-term work right on their desktops, Vicinity includes worksurfaces. This enables the creation of well organized workstations in a variety of shapes, sizes and configurations. In group spaces, Vicinity balances privacy and interaction while providing each individual with the means to personalize their storage work zones.



Top Drawer.

Double box drawers in 12" and 18" depths increase storage flexibility. Columbian Walnut laminate, Glow Etched Bronze tackboard fabric, Arch pulls and Muslin finish. Flagship® Side-Access Pedestal with Columbian Walnut laminate, Arch pull, and Muslin finish. Unanimous® Chair with Impact Sprout upholstery and Black finish.

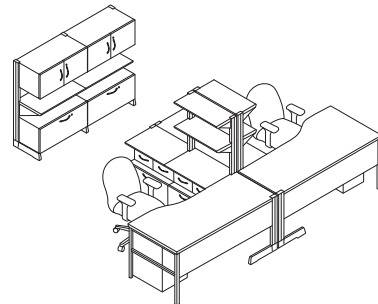



Columbian Walnut laminate, Twigs Sycamore tackboard fabric, Arch pulls and Platinum finish. F³™ Chair with Alter Ore upholstery, Black ilira®-stretch back and Black finish.

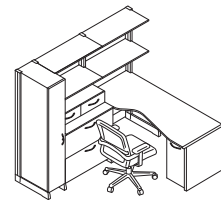

Adapts to any individual.

Vicinity supports people who like to stack things or file things or both. It even supports people who change the way they work, since it's easy to add and reconfigure components to meet new demands. Whatever the storage need, Vicinity keeps everything close at hand – from paper clips and folders to handbags and MP3 players.



Shape Up.

Different worksurface shapes and sizes support different space and user requirements. This saddle worksurface provides an ergonomic “cockpit” from which users can comfortably reach all essential materials.



On Your Side.

Adding a Flagship Side-Access Pedestal makes this space even more functional. Visually and dimensionally compatible with Vicinity, this mobile pedestal is customizable with six different storage accessories.



CITY BUILDERS MIDWEST MODERN III
japanese detail
ROBERT A. M. STERN HOUSES AND GARDENS

Organize every thing.

Configurable cabinets provide storage for a wide variety of items, from binders to supplies to equipment. Cabinets can be open or closed, equipped with locks or not, specified with shelves or outfitted with translucent SecureFit accessories. Unique articulating shelves can be used to display and organize materials. Double piling trays keep files and other papers visible and within easy reach.



Universal Tools.

All the SecureFit accessories pictured at left can be shared between the product lines above: (A) Vicinity, (B) Abound™ tiles and storage components, and (C) Flagship Side-Access Pedestals.





Organize every place.

Mailrooms, supply centers and other “backroom” operations can require even greater organizational flexibility than offices – and Vicinity is more than up to the task. A single space-efficient storage wall can accommodate virtually anything a business might need to keep it running smoothly, all organized for easy identification and access. The range of components available, and the ability to add and reconfigure them, means Vicinity can evolve along with the organization.



Efficiency Expert.

Vicinity can improve productivity in ways large and small – like providing worksurface space to organize documents right next to a copier. Natural Maple laminate, Twigs Hawthorne tackboard fabric, Radius pulls and Carob finish.

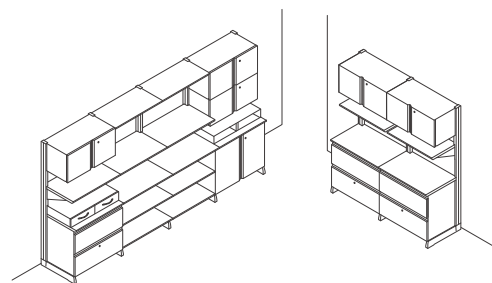





Organize every person.

Individuals can organize and stage their work in an active storage zone that includes worksurfaces, cabinets, shelves and files. Desktop screens help enhance privacy. Users can easily adjust piling trays and box drawers themselves and larger components are comfortably sized for quick installation and reconfiguration.



Shelf Esteem.

A perforated metal back panel inside hinged storage cabinets accommodates SecureFit accessories. Alternatively, cabinets can be equipped with metal shelves (in three different depths). Natural Maple laminate, Arch Macadamia tackboard fabric, Arch pulls, and Muslin and Champagne Metallic finishes. Flagship Side-Access Pedestal with Arch pull and Champagne Metallic finish. Mirus™ Chair with Defer Sesame upholstery.

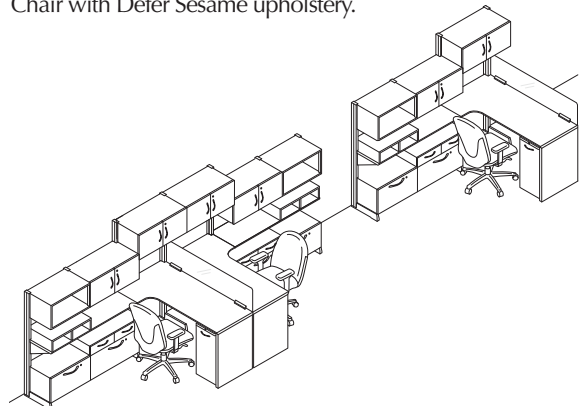





A refined appearance.

Vicinity looks more sophisticated than conventional storage lines, so it's ideal for high-profile areas like reception stations. It reinforces a company's image and capabilities even as it helps make employees more efficient. Here, open shelves can display art and promotional materials while files and cabinets provide easily accessible group storage.



Get It Together.

Initiate systems furniture is a perfect complement to Vicinity. Colombian Walnut laminate, Glow Etched Bronze tackboard fabric, Arch pulls and Champagne Metallic finish. Unanimous Chair with Medium Straw upholstery and Black finish. Initiate: panels with Glow Etched Bronze fabric and Champagne Metallic finish; worksurfaces in Colombian Walnut laminate.

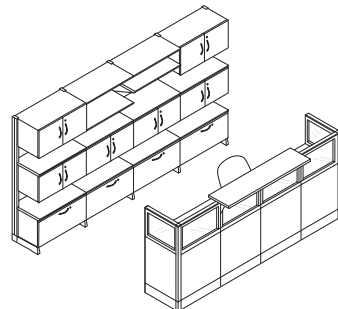

A refined approach.



Remarkable fit and finish, an extended color palette and unlimited configuration options set Vicinity apart from other storage options, making it an excellent choice for your most distinguished personnel. It performs beautifully with executive desks from The HON Company.

Complementary Colors.

Matching finishes make it easy to mix Vicinity with other products from The HON Company. Columbian Walnut laminate, Twigs Hawthorne tackboard fabric, Arch pulls and Champagne Metallic finish. F³ Low-back Chair with Lariat Lake upholstery and Black finish. F³ Guest Chairs with Axis Willow upholstery and Black finish. 10500 Desk in Columbian Walnut laminate.

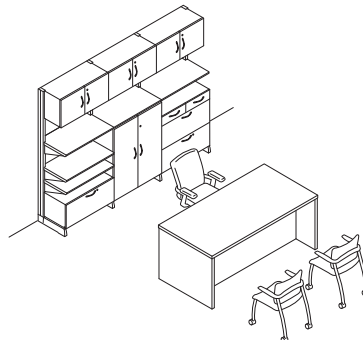

A refined mix of materials and products.



Vicinity is offered with selected laminate and paint finishes, creating a coordinated palette that ensures harmonious combinations. Vicinity also meshes perfectly with our full line of furniture – enabling you to furnish your entire organization from a single source.

A True Original.

Vicinity lends itself to creative applications – like this one-of-a-kind credenza. Shaker Cherry laminate, Radius pulls and Champagne Metallic finish. F³ Low-back Chair with Lariat Ivory upholstery and Black finish. Park Avenue Collection® Laminate Conference Table in Shaker Cherry finish.

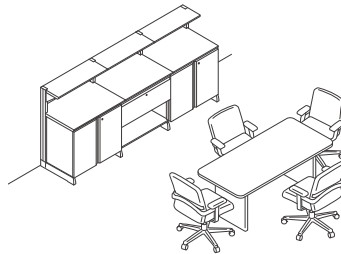





A refined value.

Vicinity can furnish everything from a mailroom to a private office to a group space – easily, affordably and with infinite flexibility for the future. The HON Company's characteristic attention to quality and durability, including all-metal columns and storage cases, ensures Vicinity will retain its beauty and strength through years of reconfigurations. All of which makes Vicinity an excellent long-term investment.



Cutting Edge.

Knife edges on worksurfaces enhance Vicinity's clean, contemporary look. Columbian Walnut laminate, Arch pulls and Champagne Metallic finish. F3 Chair and Guest Chair with Lariat Sand upholstery, Earth ilira-stretch back and Black finish.

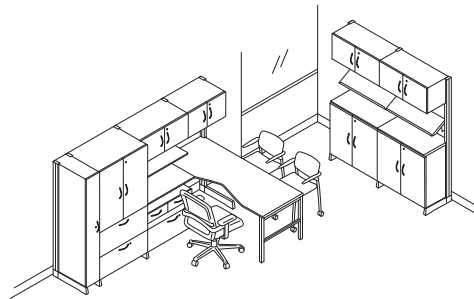

Adaptive. Organized. Refined.

Vicinity is more than just a means to contain all the “stuff” that accumulates in today’s workplaces. It’s a way to make individuals and organizations more personal, productive and pleasing.

It’s storage that works.

Visit hon.com for additional information on the unique features that make Vicinity work for private offices, open-plan spaces, group workstations, reception areas, mailrooms, conference rooms and more.



Vicinity STATEMENT OF LINE

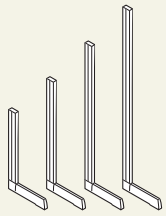

Columns

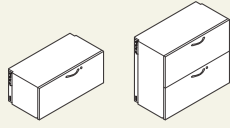

Lateral Files

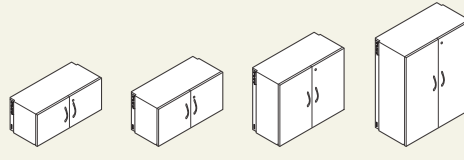

Storage Cabinets

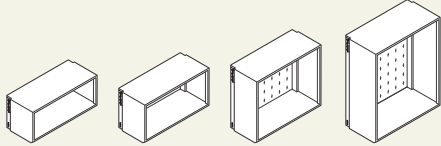

Open Cabinets

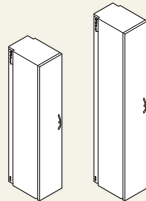

Wardrobe Storage



Articulating Display Shelves

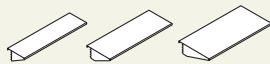

Interior Storage Cabinet Shelves



Interior Wardrobe Shelf

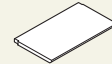

Laminate Top



Laminate Shelf

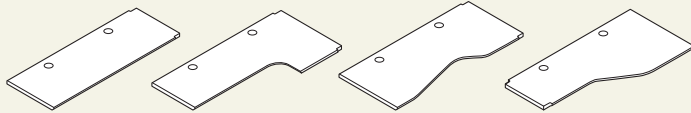

Worksurfaces



Hanging Piling Tray

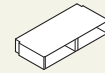

Piling Tray

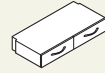

Box Drawer

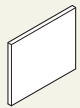

End Panel

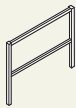

Open Leg End Panel

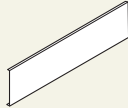

Modesty Panel

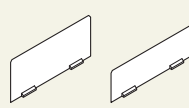

Privacy Screens

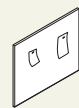

Tackboard

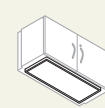

Tasklight

SecureFit Accessories



File Tub



Binder Storage



CD/DVD Holder



Pencil Tray



Piling Shelf



Folder Bin

Finishes

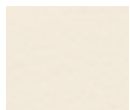

Muslin



Light Gray



Greige

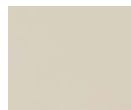

Putty

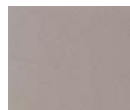

Taupe



Carob

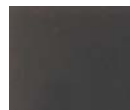

Charcoal



Black

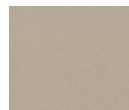

Champagne Metallic

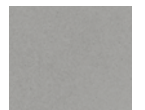

Platinum Metallic

Laminates



Sheer Mesh



Taupe Mesh



Silver Mesh



Steel Mesh



Carbon Mesh



Natural Maple



Bourbon Cherry



Shaker Cherry



Columbian Walnut



Mahogany



HON[®]
Smart now. Smarter later.

The HON Company
200 Oak Street
Muscatine, IA 52761

800-833-3964
www.hon.com