

Initiate®

panel and desk system



PLANNING GUIDE

HON®

Panels 4

Power/Data 10

Worksurfaces. 14

Overhead Storage. 18

Task Lights 18

Accessories 19

Storage 20

Deskings Shells. 22

Deskings Components 24

Specify to Win. 27

Idea Starters 28

Solutions made easy.

Easy to understand. Easy to specify. Easy to install and reconfigure.

Unlike so many competitive furniture systems, Initiate is grounded in common-sense thinking. Fewer pieces and parts. Logical connections.

Intuitive functions. No furniture system is easier to work with for designers, specifiers, installers and users alike. But easy doesn't mean unsophisticated:

Initiate is capable of creating virtually any kind of configuration and supporting any type of work style. The following pages provide a step-by-step approach to planning with Initiate.

For additional assistance, please contact your local HON dealer.

Choose your Initiate: ▶

One product line, multiple options. Choose the one that best fits your needs – or use different solutions in different areas of your company. Working with a single product line will save you time and money, now and in the future.

▶ Systems

Panel-based solutions that help define space and create privacy while maximizing your ability to accommodate change. Create everything from private offices with doors to open environments that encourage teamwork.

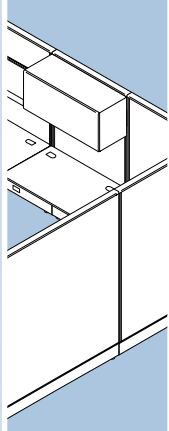

1-2-3 specify!

When planning with Initiate, start by using panels and connectors to define space and create privacy. Then determine the electrical and data connections you'll need to support user needs. Finally, add functionality to each workspace by selecting interior components – worksurfaces, overheads, accessories and storage.

SHORTCUT

We've got plenty of ideas that can jump-start and shorten your planning process. See pages 28-31.

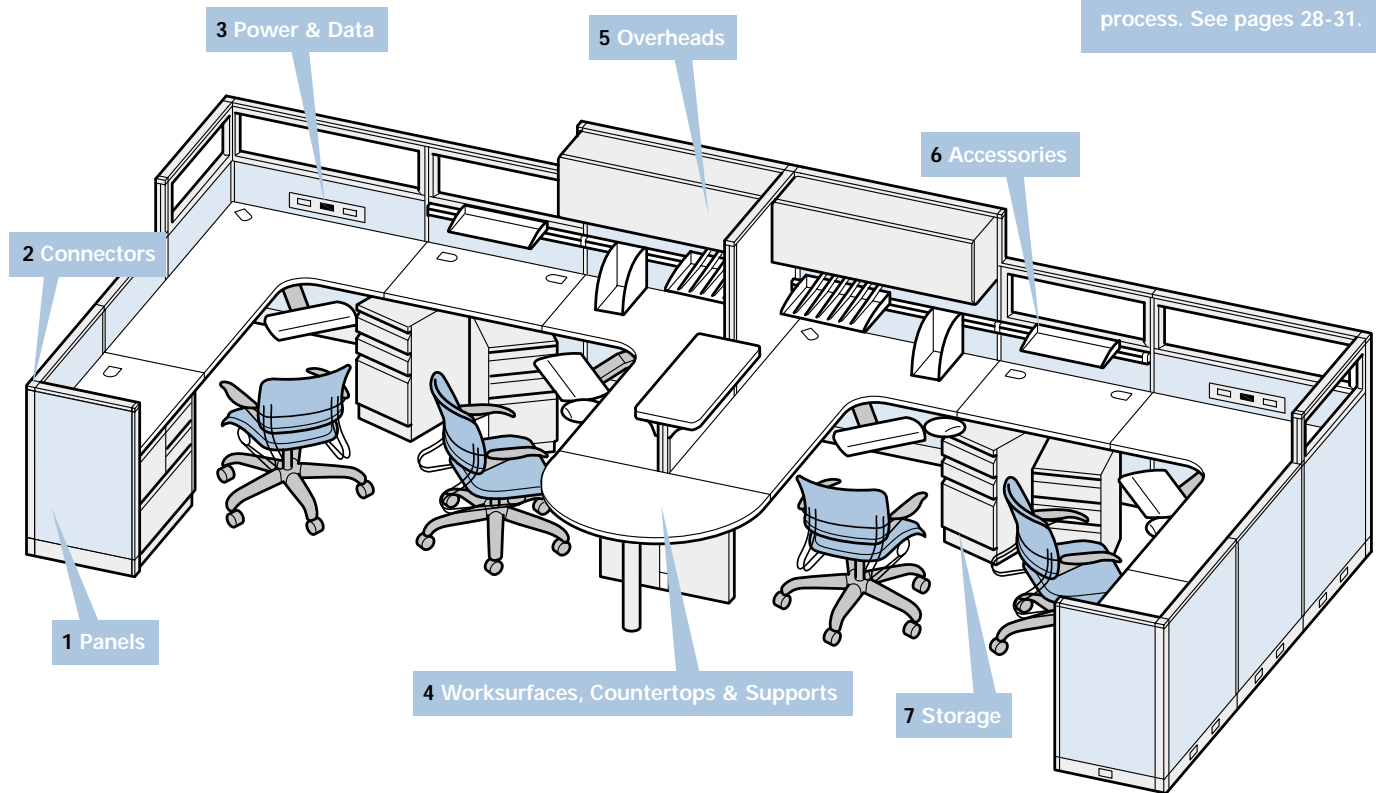

◆ Desking Shells

Desks, returns, bridges, corners and peninsulas that can be combined into a variety of freestanding configurations ideal for executive offices. Shells are visually compatible with systems to allow a unified visual aesthetic throughout an entire installation.

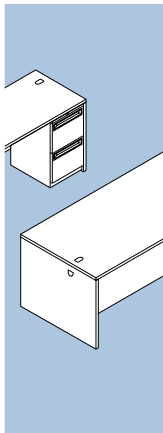

◆ Desking Components

Support components that let you convert systems worksurfaces into freestanding desks for use independently or with panels. Using the same worksurfaces for both system and freestanding configurations greatly simplifies specification, installation, reconfiguration and inventory.

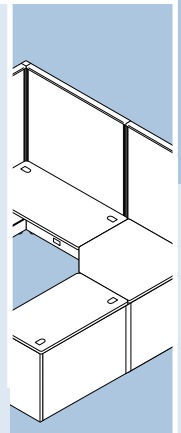

Panels

Raceway/Cableway panels



Tackable Acoustical
HEIGHT
 30", 42", 55", 68"
WIDTH
 24", 30", 36", 42",
 48", 60"

HEIGHT
 81"
WIDTH
 24", 30", 36",
 42", 48"

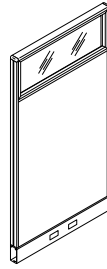

Top Tier Clear Glass
HEIGHT
 42", 55", 68", 81"
WIDTH
 24", 30", 36",
 42", 48"

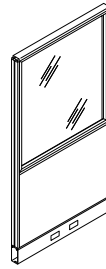

Worksurface Height Clear Glass
HEIGHT
 68", 81"
WIDTH
 24", 30", 36"

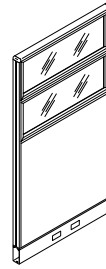

Double Top Tier Clear Glass
HEIGHT
 68", 81"
WIDTH
 24", 30", 36",
 42", 48"

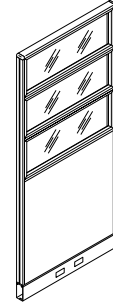

Triple Top Tier Clear Glass
HEIGHT
 81"
WIDTH
 24", 30", 36",
 42", 48"

Panels are 2" thick and include levelers for 2" of adjustment.

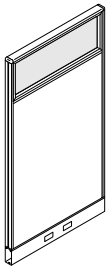

Top Tier Frosted Glass
HEIGHT
 42", 55", 68", 81"
WIDTH
 24", 30", 36",
 42", 48"

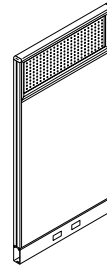

Top Tier Perforated Metal
HEIGHT
 42", 55", 68", 81"
WIDTH
 24", 30", 36",
 42", 48"

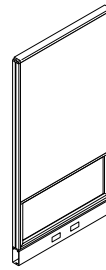

Bottom Pass-Thru
HEIGHT
 30", 42", 55",
 68", 81"
WIDTH
 24", 30", 36",
 42", 48"

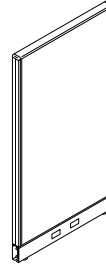

Non-Tackable
HEIGHT
 30", 42", 55", 68"
WIDTH
 24", 30", 36", 42",
 48", 60"
HEIGHT
 81"
WIDTH
 24", 30", 36",
 42", 48"

Raceway panels accept electrical power harnesses and include cut-outs for electrical receptacles and dat ports. They are used to bring power/data to a workstation.

Cableway panels do not accept electrical power harnesses, but cables can be routed through the pathways at panel bases. Cableway panels do not accommodate receptacles, so there's no power access.

Power panels

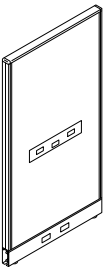

Single Sided Power
HEIGHT
 42", 55", 68", 81"
WIDTH
 36", 42", 48"

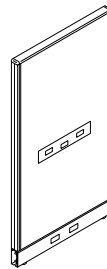

Double Sided Power
HEIGHT
 42", 55", 68", 81"
WIDTH
 36", 42", 48"

Privacy enhancers

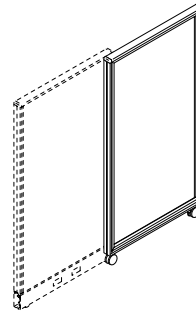

Sliding Privacy Screen
HEIGHT
 68"
WIDTH
 36"



Door and Frame
HEIGHT
 81"
WIDTH
 42"

Raceway panels and cableway panels are visually and functionally compatible, so they can be linked together. See page 27 for a cost-saving way to combine them.

Panels with a purpose

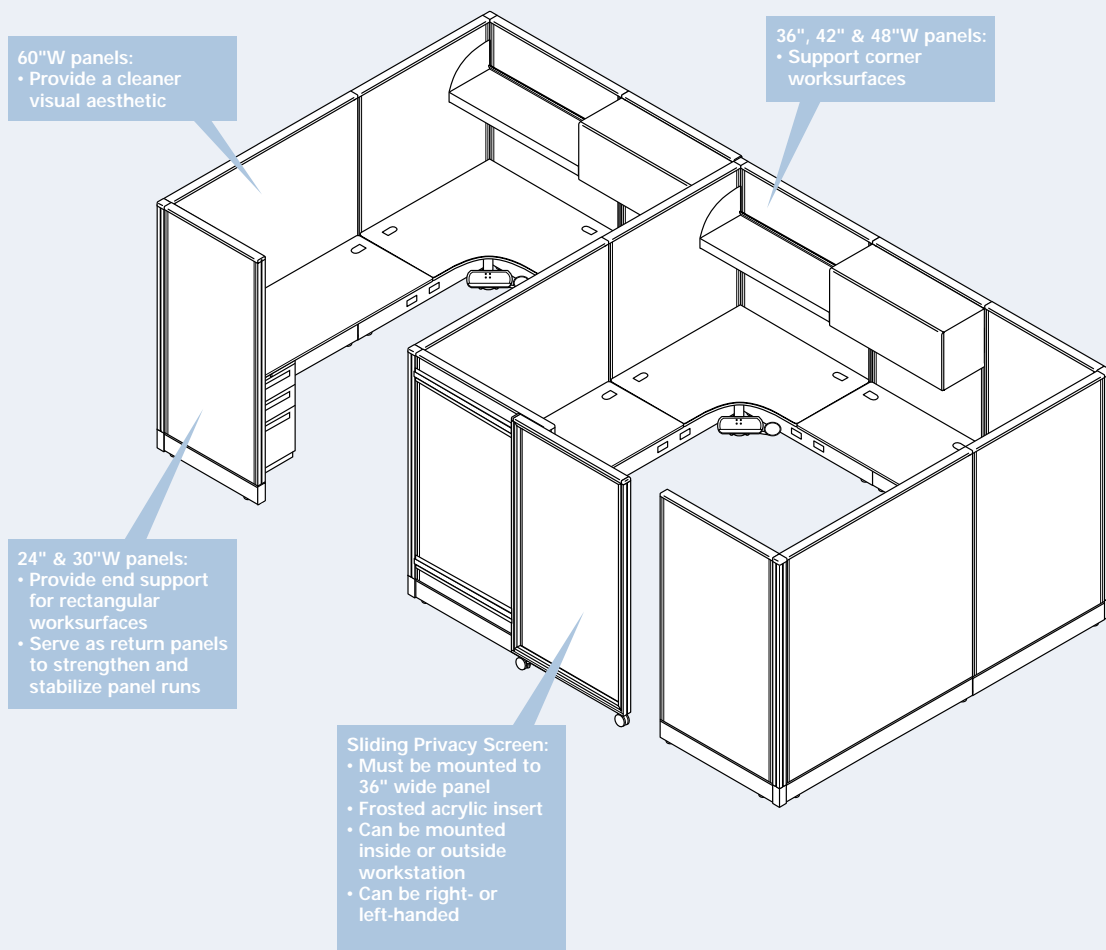
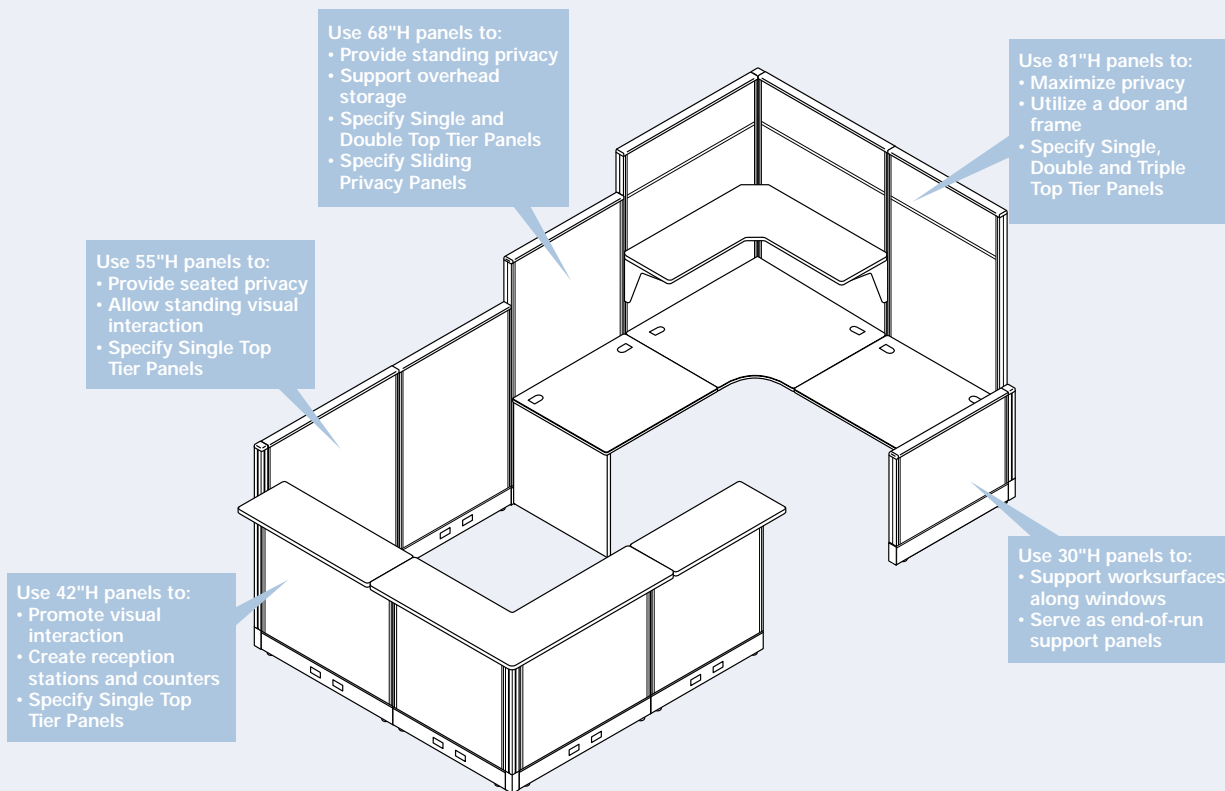

Connecting Panels

Simple panel connections make specification, installation and reconfiguration easy.

I-Connector

- Join adjacent panels for a precise fit
- Come standard with each panel and with universal connectors
- (2) per 30"H panel, (3) per 42"H panel, (4) per 55"H panel, (5) per 68"H panel, (6) per 81"H panel



Universal Connector

- Join adjacent panels in
 - 2-way "L" configurations
 - 3-way "T" configurations
 - 4-way "X" configurations
 - Extended straight configurations
- Includes (1) variable-height connector bracket, (4) universal connector brackets, (1) 2-way baserail cover and (1) 3-way baserail cover

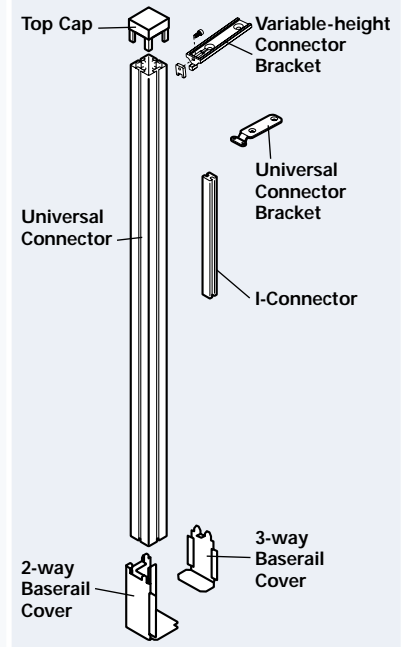
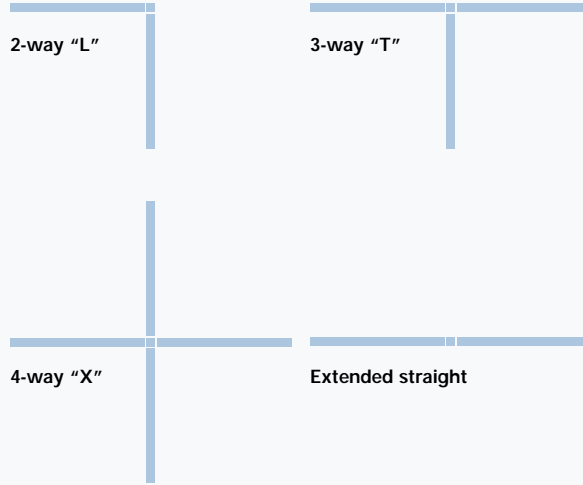

120° Universal Connector

- Join adjacent panels at 120° angles in 2- or 3-way configurations
- Includes (1) variable-height connector bracket, (3) universal connector brackets and (1) 2-way baserail cover

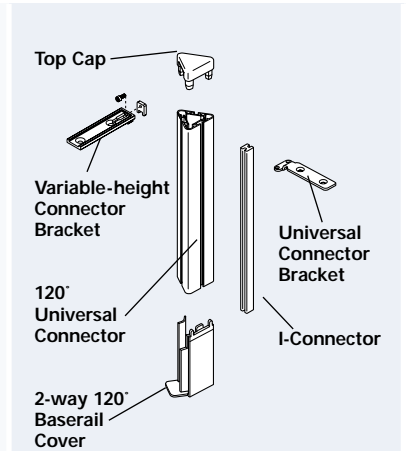
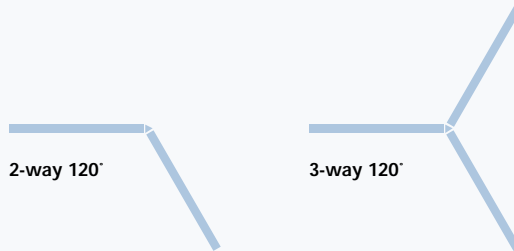

When changing panel height at a 2-way, 3-way or 4-way connection, always specify the universal connector to match the tallest panel height.

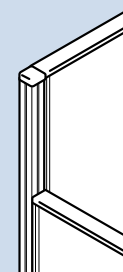

Filler strips are available to "finish" the exposed ends of panels and connectors. Each strip is 81" high; installers field-cut them to any size needed.



Baserail Cover

- Finish the connector base and maintain a seamless look with adjacent panels
- (1) 2-way cover and (1) 3-way cover included with each universal connector

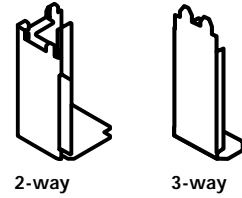

Baserail End Cover

- Finish the base at the end of every panel run (except when attaching panels to permanent walls)
- Includes (2) baserail end covers and (2) top end caps
- Must be ordered separately



Top End Cap

- Finish the top at the end of every panel run (except when attaching panels to permanent walls)
- (2) come standard with baserail end covers – see above
- Order separately to finish off corners in variable-height panel configurations

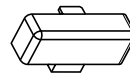

Variable-height Connector Bracket

- Connect two panels of different heights
- (1) included with each universal connector – hang on to extras for reconfigurations!
- Additional brackets needed for multiple height changes at 2-, 3- or 4-way configurations
- Specify a bracket for each in-line panel height change, too

TIP: Inventory additional brackets to accommodate reconfigurations.

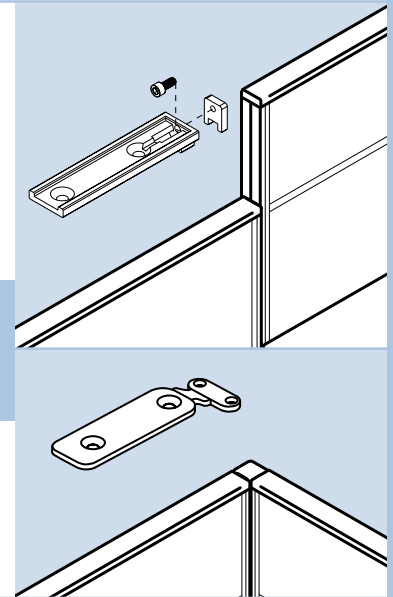

Universal Connector Bracket

- Connect panels of the same height to a universal connector
- (4) included with each universal connector

Wall Starter

- Connect a panel to a permanent wall
- Mounted with customer-supplied hardware

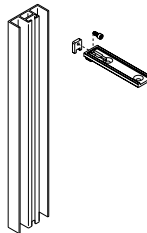

Sleek-to-Initiate Connector

Sleek is a HON panel system offering a distinctly different aesthetic than Initiate – but the two can be combined to meet budgetary and functional requirements. See Sleek pricer information for more details.

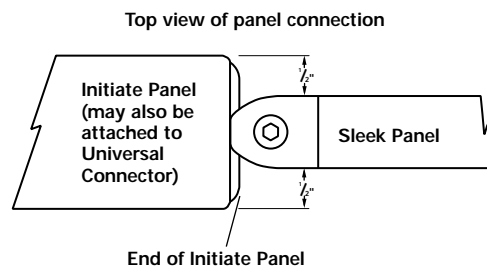

Sleek™ Alert!

Sliding to the Rescue

Sliding privacy screens let users temporarily separate themselves from the rest of the office when they need to focus or have a closed-door conference. Opaque plexiglass insert blocks visual access while filtering in light. Must be mounted to a 36"-wide panel only. This is a more cost-effective alternative than a panel-hung door. Must be mounted to 68" or 81"H panels.

TIP: Sliding privacy screens are a more cost-effective alternative than a panel-hung door.

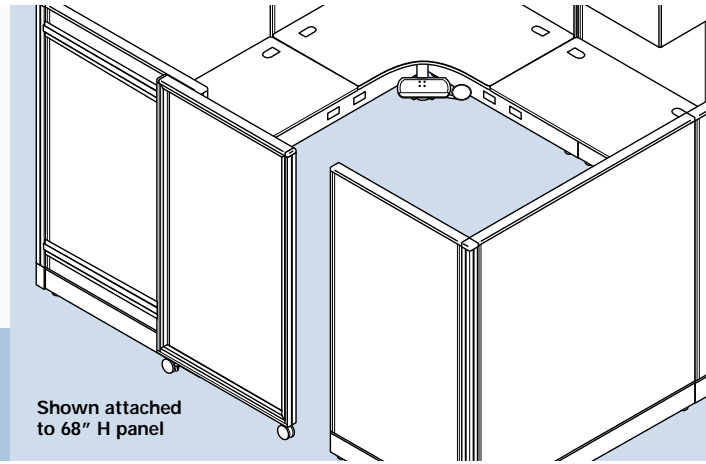

Open and Shut Case

For optimum privacy, specify a door for attachment to 81" panels. A door knob (in polished brass) or lever (polished aluminum) must be specified separately. Knobs and levers are both keyed on one side.

TIP: 81"H panels maximize privacy without the expense of drywall construction. Unlike permanent walls, you can easily move and rearrange panels!

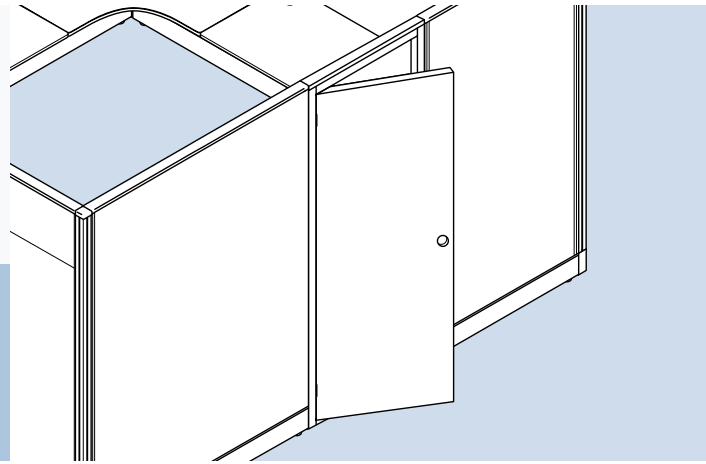

No Creep Factor

"Panel creep" refers to the addition of inches along a run of panels due to the connections between panels. With competitive systems, these inches can add up to a significant dimension on long panel runs. But that's not the case with Initiate - I-connectors don't add any creep at all!

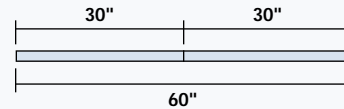

I-connectors have a creep factor of zero. So, for example, two 30-inch wide panels will equal 60 inches.

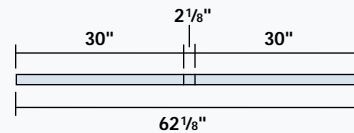

Universal Connectors have a creep factor of 2 1/8". Two 30-inch wide panels will equal 62 1/8".

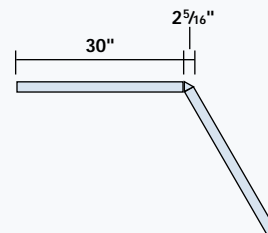

120° Universal Connectors have a creep factor of 2 5/16".

TIP: You pay for panel creep by the square foot. The creep factor in other panel systems can increase the square footage of complex layouts by 12% or more. This can have a tremendous effect on the cost per occupant of your space, as well as the number of employees your space can accommodate.

Panel Stability Rules

Initiate panels offer exceptional strength and superior durability. But they can't stand up by themselves!

To ensure proper stability, you should follow one of these two methods in your planning:

Opposing Return Panels

- The length of a parent panel run (C) must equal at least 4 feet and no more than 12 feet
- Must be a minimum of two return panels (A, B)
- When return panels extend in opposing directions on each side of the parent run, the combined length of the return panels (A + B) must equal at least 20% of the parent run

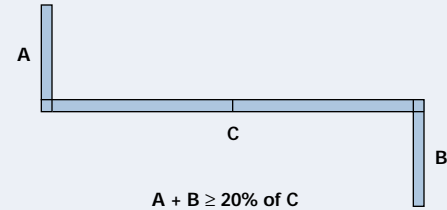

Same-side Return Panels

- The length of a parent panel run (C) must equal at least 4 feet and no more than 12 feet
- Must be a minimum of two return panels (A, B)
- When return panels extend in one direction from the parent run, the combined length of the return panels (A + B) must equal at least 60% of the parent run
- The minimum length of the return panels (A + B) is 6 feet

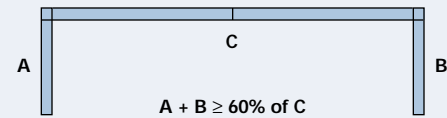

TIP: A freestanding pedestal or two-drawer lateral file supporting a panel-hung worksurface will add additional stability to a panel run.

SLEEK SAVINGS

Panels from another HON panel system, Sleek, can be used as return panels in conjunction with Initiate panels to reduce overall project cost. Because Sleek panels are thinner than Initiate, different panel stability rules apply. See the Sleek List Pricer pages for details.



Power to the panel

Initiate provides a four-circuit, eight-wire electrical system that delivers four circuits for every power infeed in either a 3 + 1 or 2 + 2 configuration. You may also choose a three-circuit, eight-wire system that has a dedicated neutral for every hot circuit. You should consult your electrician and computer support personnel to determine the best solution for your needs.

Power In-Feed

- Carries power from the building to the Initiate system
- Available for Base, Ceiling and Hardwire applications

Always consult an electrician on local codes and ordinances before starting any electrical project.

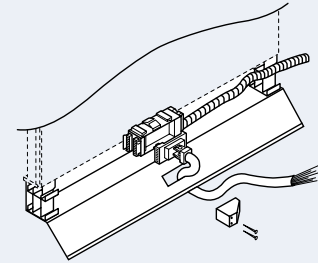

TIP: Must be positioned through a receptacle opening in the baserail cover prior to an electrician connecting to the power source.

Power Pole

- All ceiling in-feeds must be routed through a power pole
- Power poles fit atop universal connectors
- Power pole/universal connector combinations must be routed through an “L”, “X” or “T” connection



Electrical Power Harness

- Carries power from in-feed to panels
- Distributes power in both directions and angles to handle corners and “T” connections
- Includes two power blocks; receptacles can be inserted into both sides of each
- 3-way panel connections require at least (1) power harness
- 4-way panel connections require at least (2) power harnesses
- Extra connector allows power to be routed in two directions
- Maximum flexibility for electrical outlet placement
- Maximum reconfiguration flexibility

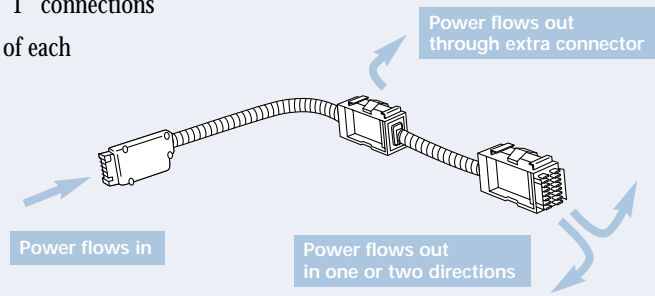

Electrical Pass-Thru Cable

- Includes one power block; receptacles can be inserted into both sides
- Cannot change direction; restricts placement of outlets
- A more economical alternative than an electrical power harness – but it offers less flexibility

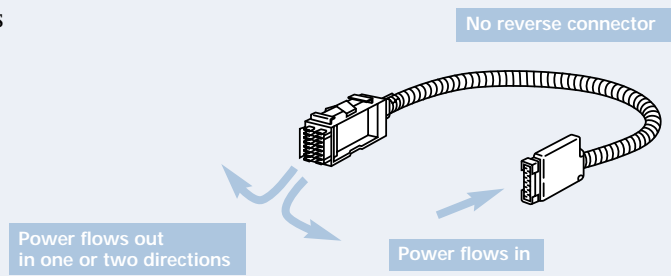

Positioning Harnesses

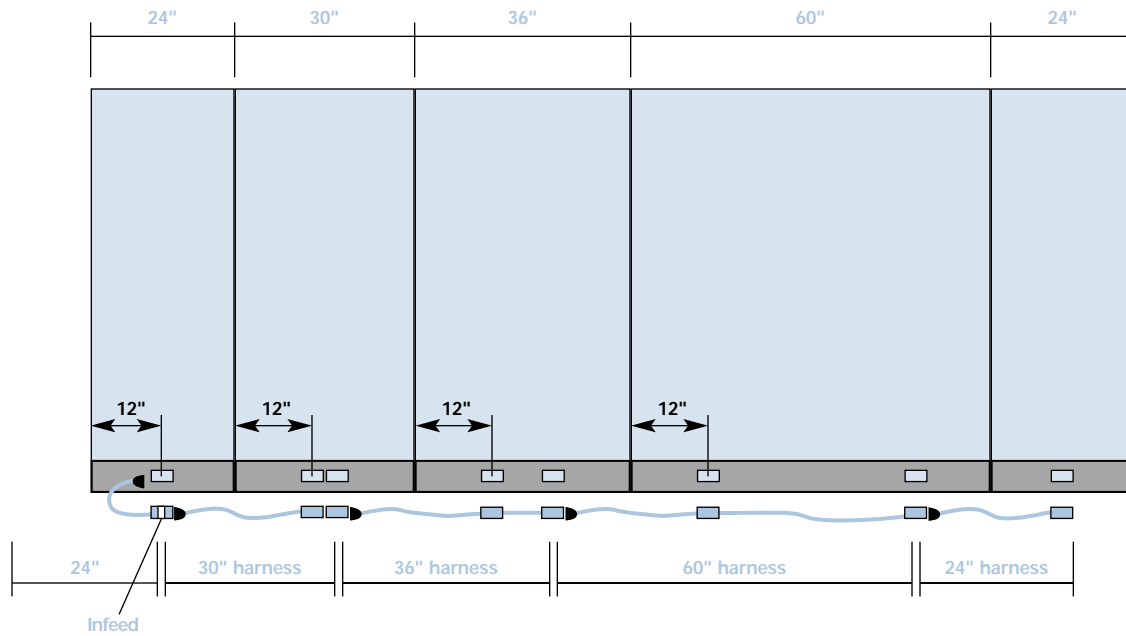

- Specify harnesses to match the width of panels – they're listed this way in the HON List Pricer
- Receptacle grommets are centered 12" from the edge of the panel, regardless of panel width
- The difference in panel and harness size is made up between the grommets

Using Pass-Thru Cables

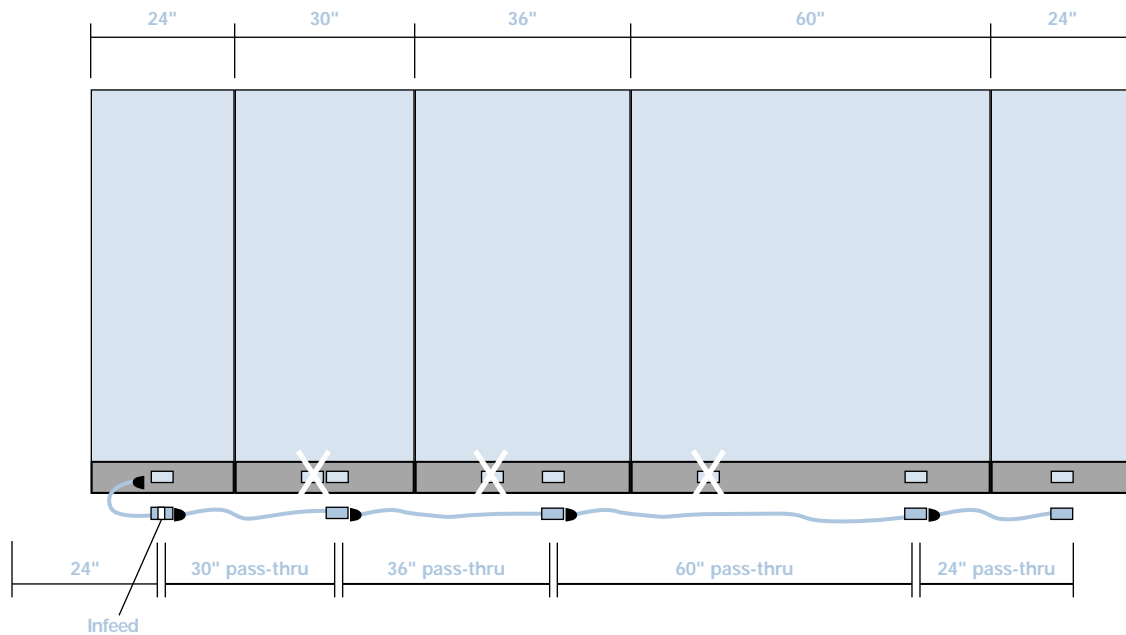

- Pass-thru cables are more economical than electrical harnesses – but they only allow one receptacle per panel!

Power Panels

- Eliminate the need to order harnesses and pass-thru cables
- Single-sided and double-sided power panels offer planning flexibility
- All powered panels come with a harness that brings electrical from raceway to beltline – i.e, worksurface height
- There's nothing to order but duplex receptacles:
 - up to (8) per side: (4) at raceway and (4) at beltline – that's (16) potential receptacles for a double-sided power panel!
- Center channel routes data wires from panel base to beltline, too
- Talk to your electrician regarding Chicago power applications



Power panel delivers electrical and data connections at worksurface height.

TIP: Specify power panels when you want beltline power. Raceway panels and electrical power harnesses do not give you this capability.

Pass-Thru Panels

- 15" opening above baserail allows easy access to power and data outlets when panels are placed against a permanent wall
- Available in raceway and cableway versions

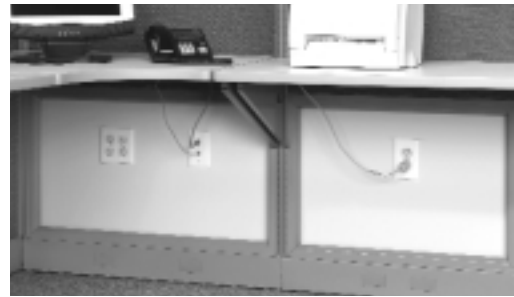

Pass-Thru Panels have a 15"H opening to allow easy access to power and data outlets when panels are placed against an architectural wall.

Other Power Options

Data and Electrical Receptacle

- Contains (1) 15-amp outlet, (1) data port and 6-ft. power cord
- Mounts into worksurface grommet

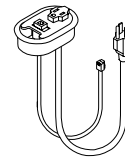

Communication Dome

- Contains (2) 15-amp outlets, (2) data ports and 6-ft. power cord
- Mounts into worksurface grommet or panel slot

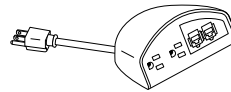

Beltline Power/Data

- Standard with 4 receptacles and openings for (2) data ports
- Attaches to slots in panels to bring access closer to the user
- Can be positioned above or below worksurface

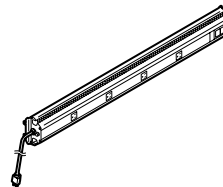

Pull-up Receptacle

- Contains (4) 15-amp outlets, circuit breaker and 6-ft. power cord
- Mounts into worksurface grommet
- MAY interfere with under-the-worksurface storage options

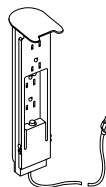

Circuit Strategies

Four-circuit, 3 + 1 Receptacle Option

- #1 option for 95% of the market
- Three utility circuits are suitable for faxes, copiers, task lights, etc.
- One isolated/dedicated circuit is ideal for sensitive computing equipment

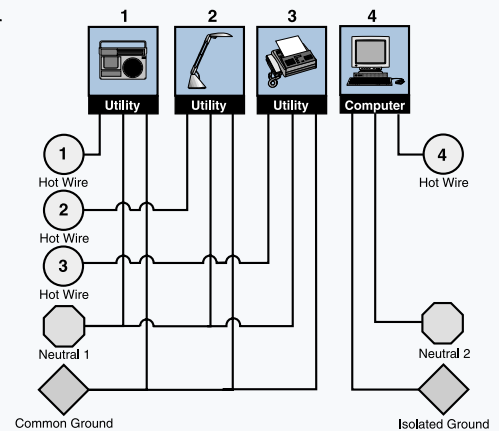
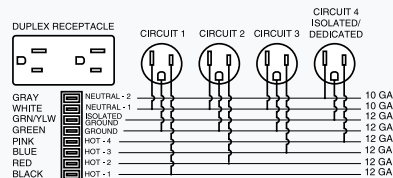

Four-circuit, 2 + 2 Receptacle Option

- Ideal for environments where computers outnumber other business machines
- Circuits 1 & 2 are suitable for faxes, copiers, task lights, etc.
- Circuits 3 & 4 are for computers

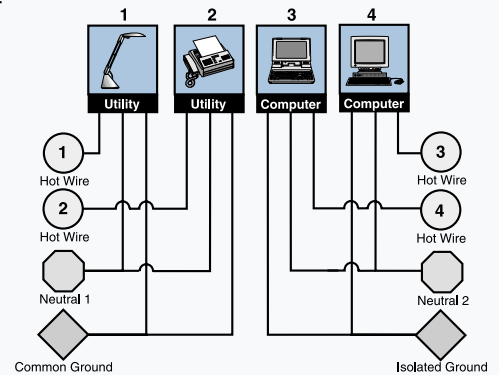
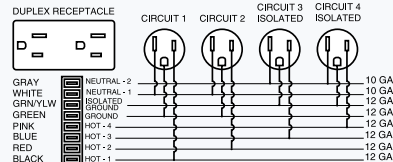

Three-circuit, Separate Neutrals

- Only three circuits available, each with its own neutral wire
- Circuit 3 has isolated ground
- Only 3 circuits means 30% more infeeds
- NOT our recommended solution, but may be appropriate when either a 240Y/120-volt or 208Y/120-volt power distribution system exists and separate neutral circuits are required.

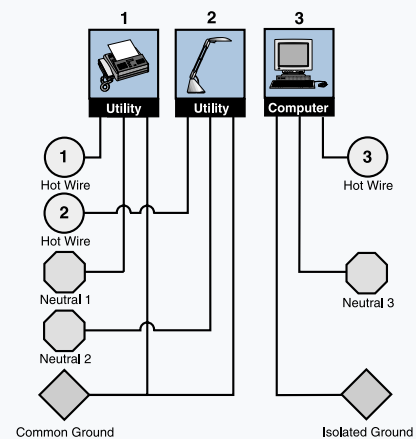
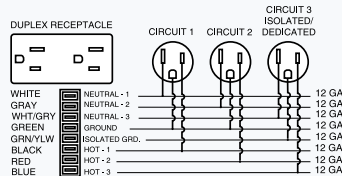

Worksurfaces

Initiate worksurfaces, like Initiate panels, ship standard with most hardware – making them easier to specify and install!

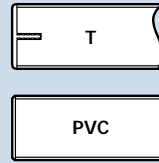

EDGE OPTIONS

Worksurfaces are standard in a T-mold edge or PVC edge. Edge colors must be specified separately.

Rectangular

- Includes (2) cantilever brackets
- 60"+ wide worksurfaces have a metal channel underneath to prevent bowing
- 30"+ wide worksurfaces are standard with (2) wire management grommets
- Worksurface must correspond to width of panel behind it or may span 2 panels that equal its width
- 66"W and 72"W worksurfaces require one or more of the following in addition to the cantilever brackets:
 - Worksurface support bracket
 - End panel
 - Universal support leg
 - Pedestal or 2-high lateral support

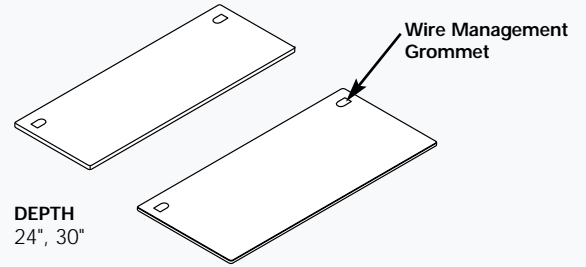
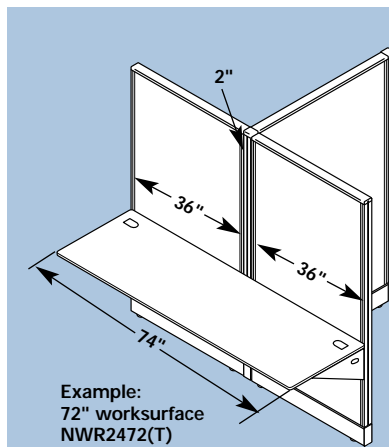

DEPTH
24", 30"

WIDTH
24", 30", 36", 42", 48", 60", 66", 72"

FIT TO A "T"

When using a rectangular worksurface to span a "T" or extended straight panel connection made with a universal connector, add a "T" suffix to the model number of the worksurface.

This adds 2" to the worksurface!

Corner Cove

- Includes a rear support bracket
- 72"W worksurfaces include a center support bracket, too
- Use Samba® or HKB800 keyboard platforms

TIP: Save money by using a corner cove instead of a corner worksurface and return.

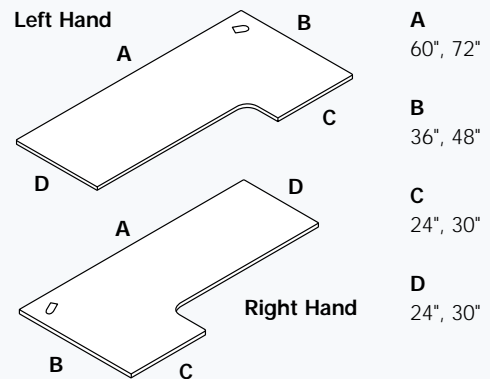

Corner with Curved User Edge Symmetrical

- Includes (2) cantilever brackets and (1) corner bracket
- If adjacent worksurface is a different height, a "Z" bracket is recommended
- Must match exactly the panel width behind it

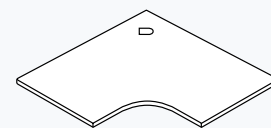

DEPTH
24" 30"

WIDTH
36", 42", 48" 42", 48"

Corner with Straight User Edge

- Includes (2) cantilever brackets and (1) corner bracket
- If adjacent worksurface is a different height, a “Z” bracket is recommended
- Must match exactly the panel width behind it
- Use Samba® or HKB800 keyboard platforms

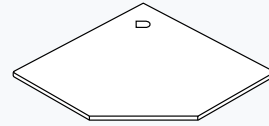

DEPTH
24" 30"

WIDTH
36", 42", 48" 42", 48"

Provides more worksurface space than curved edge corners.

Corner with Curved User Edge Variable Depth

- Includes (2) cantilever brackets and (1) corner bracket
- Must match exactly the panel width behind it

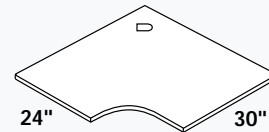
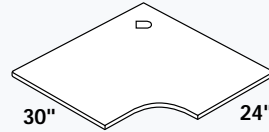

42"W x 24"D left, 30"D right
42"W x 30"D left, 24"D right
48"W x 24"D left, 30"D right
48"W x 30"D left, 24"D right

120° Corner Worksurface with Curved User Edge

- Includes (2) cantilever brackets and (1) corner bracket
- If adjacent worksurface is a different height, a “Z” bracket is recommended
- Must match exactly the panel width behind it
- Use Samba® or HKB800 keyboard platforms

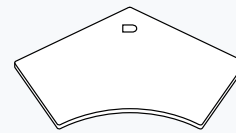

DEPTH
24" 30"

WIDTH
36", 42", 48" 42", 48"

If used at the end of a panel run, an end panel is recommended for additional support.

Split Top Worksurface

- Includes (2) cantilever brackets and (1) corner bracket
- Must match exactly the panel width behind it
- Adjustable Height Mechanism (HKHSM100) must be ordered separately

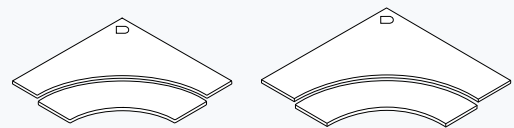

DEPTH
24" 30"

WIDTH
36", 42", 48" 42", 48"

Wire management grommets are standard on all worksurfaces EXCEPT:

- half-round
- 24"W
- countertops

Adjustable Height Mechanism raises the keyboard platform 12.5" above worksurface and 6.5" below worksurface; platform tilts 15° positive and 15° negative.

Peninsula

- Must match width of its support panel
- Can also be attached perpendicular to a primary worksurface using Flat or "Z" brackets
- Do not attach to a worksurface supported with cantilever brackets
- Support column ordered separately

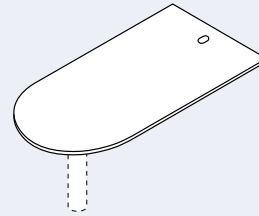

LENGTH
60", 66", 72"

WIDTH
30", 36"

An easy way
to make any office
into a
conference room!

Half-Round

- Connects to two 24"D worksurfaces
- OR
- Connects to two 30"D worksurfaces
- Requires one support column and two universal support legs or full end panel
- Creates a transaction surface between workstations
- Support column ordered separately

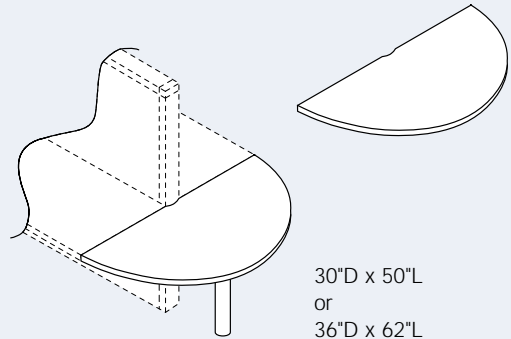

30"D x 50"L
or
36"D x 62"L

Quarter-Round

- Connects to two 24"D worksurfaces
- OR
- Connects to two 30"D worksurfaces

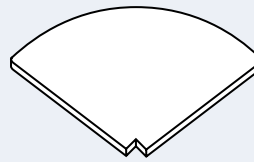

24"D x 24"L
or
30"D x 30"L

Straight Countertop

- Use with lower-height panels to provide a transaction surface between workstations in teaming and groupwork environments
- Use with lower-height panels in a reception station

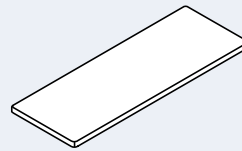

WIDTH
24", 30", 36", 42", 48", 60", 66", 72"

DEPTH
15"

Corner Countertop

- Requires two panels of corresponding width joined in a 90° connection
- Use with straight countertops to extend transaction and greeting space

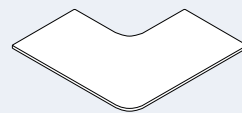

24"W x 24"D
30"W x 30"D
36"W x 36"D

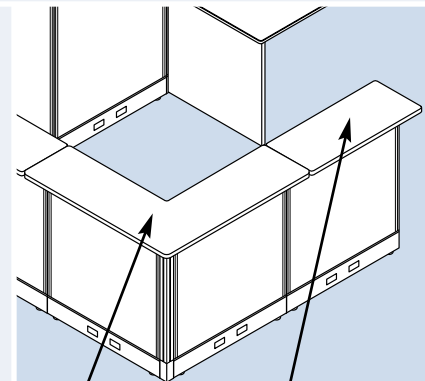

Corner
Countertop

Straight
Countertop

Worksurface Supports

Full End Panel

- Required at end of worksurface run if there is no return panel
- Notch at bottom accommodates panel baserail

Universal Support Leg

- At least one required per every 10 feet of a worksurface run
- Notch at bottom accommodates panel baserail

Support Column

- Used to support one end of a peninsula or half-round worksurface

Cantilevers

- (2) included with all rectangular, corner, and corner cove worksurfaces
- Additional pairs may be ordered separately
- Left- and right-handed
- Wire management opening

Flat Bracket

- Used to connect one worksurface perpendicular to another worksurface

“Z” Bracket

- Used to connect one worksurface perpendicular to a worksurface of a different height

Worksurface Bracket Kit

- Used to connect the end of a worksurface to a panel of the same width
- Highly recommended at return panel end for all worksurfaces for added stability
- Provides clearance for a pedestal or lateral at end of worksurface
- Anchors and solidifies entire panel installation

Permanent Wall Hanger Kit

- Used to attach worksurfaces, storage cabinets and bookshelves to a permanent wall
- Mounts to wall with customer-supplied hardware

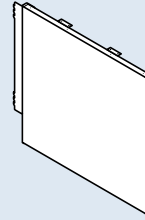

Full End Panel
HEIGHT 29"
DEPTH 24", 30"



Universal Support Leg
HEIGHT 29"
DEPTH 15 1/2"

For 10-foot or wider worksurface installations:

- A full end panel, universal support leg, worksurface support pedestal or 2-high lateral must be used at 90° panel junctions – or in a shared position to support adjoining worksurfaces.

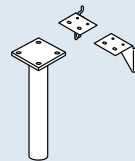

Support Column
HEIGHT 29 1/2"

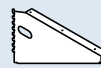

Cantilevers
DEPTH 24", 30"



Flat Bracket



“Z” Bracket



Worksurface Bracket Kit



Permanent Wall Hanger Kit

DO NOT:

- Position cantilevers at the end of a panel run.
- Use cantilevers to support worksurfaces from which a hanging pedestal is suspended, or to which a peninsula worksurface is attached.

Overhead Storage

Corner Shelf

- Cost-effective choice for overhead storage

Storage Cabinet with Flipper Door

- Painted or fabric door options
- Factory-installed core removable lock on cabinet underside
- 60" units are one piece with two doors
- Shipped assembled for easy installation and reconfiguration

Open Half-Height Bookshelf

- Shipped assembled for easy installation and reconfiguration
- Shelf dividers may be ordered separately

Task Lights

Overhead-mounted

- Four widths correspond with 24"W, 36"W, 48"W and 60"W panels
- Mount recessed under storage unit or shelf with spring steel clips
- Two 30" overhead-mounted lights can be mounted under 60"W storage cabinets

Panel-mounted

- Four widths correspond with 24"W, 36"W, 48"W and 60"W panels
- Brackets adjust to allow attachment to same size or smaller panels
- Placement recommendation: 14" to 17" above worksurface
- DO NOT use as a shelf or transaction surface

Panel-mounted Articulating

- Four adjustment points and 27" of horizontal reach
- CANNOT be used freestanding

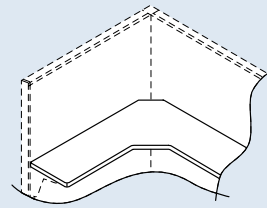

Corner Shelf
36" x 36" x 12"D
42" x 42" x 12"D

TIP: Install a corner shelf beneath a worksurface for convenient storage of shoes, purses, etc.

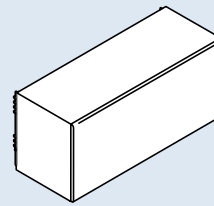

Storage Cabinet with Flipper Door
WIDTH
24", 30", 36", 42", 48", 60"

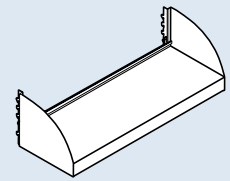

Open Half-Height Bookshelf
WIDTH
24", 30", 36", 42", 48", 60"

DEPTH **HEIGHT**
14 1/4" 16"

DEPTH **HEIGHT**
13 1/4" 8"

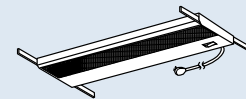

Overhead-mounted Task Light

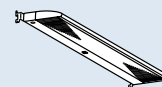

Panel-mounted Task Light

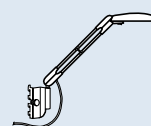

Panel-mounted Articulating Task Light

Accessories

Paper Management Support Bar

- Attaches to panels to accommodate workflow accessories: paper shelf, accessory shelf, phone tray, CD/pencil holder, sorter tray, folder bin (see HON List Pricer for details)
- Recommended weight capacity not to exceed 80 pounds

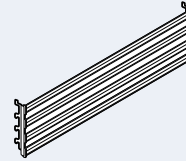

Paper Management Support Bars
WIDTH
24", 30", 36", 42", 48", 60"
HEIGHT
5"

Tackboard

- Attach to panels via slots
- Multiple boards can be used next to each other on separate panels
- CANNOT be used on 55"H panels when overhead storage is used

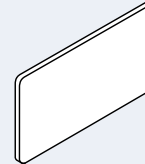

Tackboard
HEIGHT
18"
WIDTH
24", 30", 36", 42", 48", 60"

Markerboard

- Attach to panels via slots
- Multiple boards can be stacked on a single panel
- Multiple boards can be used next to each other on separate panels
- Low-glare white porcelain magnetic writing surface
- Can be used as a projection screen

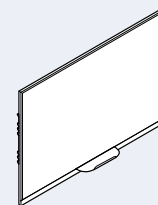

Markerboard
HEIGHT
18"
WIDTH
30", 36", 42", 48"

TIP: You cannot use two markerboards side by side at the same height at a 90° panel connection.

Flat Screen Holders

- Holds flat screen monitors up to 25 pounds
- Attaches to worksurface via clamp or panel via slots
- 360° horizontal rotation from worksurface-mounted base
- 180° horizontal rotation from panel-mounted base

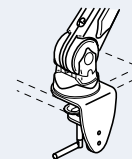

Worksurface-mounted Flat Screen Holder

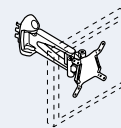

Panel-mounted Flat Screen Holder

Keyboard Platforms

The HON company offers a variety of keyboard platforms to meet different functional and budgetary requirements. Please consult the HON List Pricer for details.

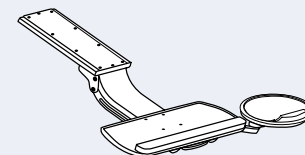

Keyboard Platform

Storage

The HON Company offers a wide variety of storage options for use with its various systems products. **Flagship®** is our premium storage line, offering the most sophisticated construction methods and the widest range of pull styles (including the Arch pull) and finishes (including white aluminum). **Efficiencies®** storage solutions offer a different drawer suspension method and fewer pull styles. Efficiencies is typically priced 8-15% less than Flagship. Perfect for the budget-minded Initiate installation!

Pull Styles



A
Arch
(Flagship only)



R
Radius
(Flagship & Efficiencies)



N
iNtegral
(Flagship & Efficiencies)



K
38000 Style
(Flagship & Efficiencies)

Pedestals

- Flagship pedestals offer double-wall drawer construction and steel ball-bearing drawer suspension
- Efficiencies pedestals offer cradle suspension on file drawers and roller suspension on box drawers
- File drawers allow front-to-back filing
- Equipped with HON "One Key" interchangeable core removable locks

FLUSH KICK PLATE
Available to fill in the "inset" at the bottom of pedestals.

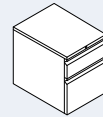

Hanging Pedestal
HEIGHT 19"
DEPTH 19 7/8", 22 7/8"
WIDTH 15"

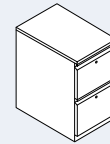

Mobile Pedestal
HEIGHT 28"
DEPTH 19 7/8", 22 7/8", 28 7/8"
WIDTH 15"

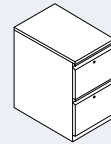

Freestanding Pedestal
HEIGHT 28"
DEPTH 19 7/8", 22 7/8", 28 7/8"
WIDTH 15"

Personal Storage Tower

- Closet and (2) adjustable shelves with a box/box/file on right or left OR
- Closet and (2) adjustable shelves with a file/file on right or left

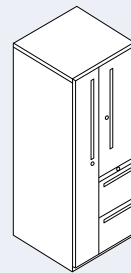

Personal Storage Tower
30"W x 18"D x 64 1/4"H

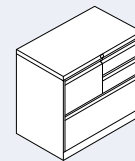

Personal File Center

Personal File Center

- Combines lateral file and pedestal into one unit
- 28"H center fits under standard Initiate workspaces
- Box and file drawer locations can be switched in the field

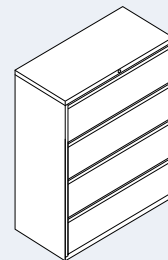

Lateral File
WIDTH 30", 36", 42
DEPTH 18"
HEIGHT 28", 39 1/8", 52 1/2", 64 1/4"

Consult the HON List Pricer for additional Storage Cabinets, Bookcases, Desk Towers and more.

Lateral File

- Available in 2-, 3-, 4- and 5-drawer configurations
- 28"H lateral fits under standard Initiate workspaces
- 5-drawer lateral file has a roll-out posting shelf and complements Initiate panel heights

Pedestals & Wire Management

24"D worksurfaces and 19⁷/₈"D peds:

- Provide some room for cables behind pedestal but DO NOT accommodate communication domes, data & electrical receptacles, or pull-up receptacles

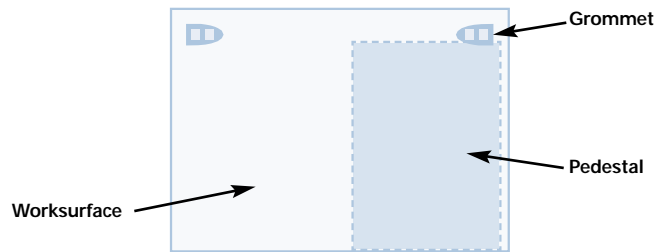

24"D worksurfaces and 22⁷/₈"D peds:

- Completely block worksurface grommet and inhibit wire management



30"D worksurfaces and 22⁷/₈"D peds:

- Provide free access to worksurface grommet and DO accommodate communication domes, data & electrical receptacles, or pull-up receptacles

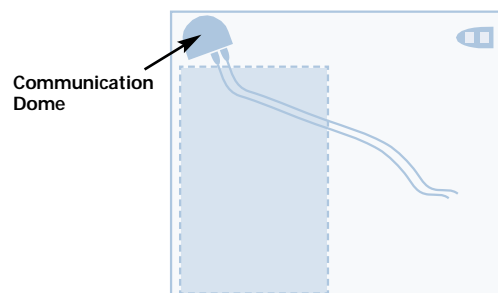

30"D worksurfaces and 28⁷/₈"D peds:

- Completely block worksurface grommet and inhibit wire management

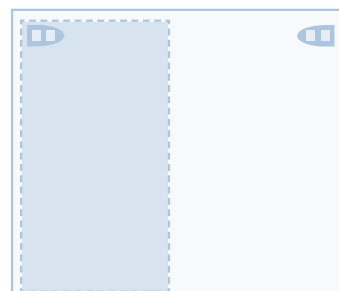

36"D desking shells and 28⁷/₈"D peds:

- Provide free access to worksurface grommet and DO accommodate communication domes, data & electrical receptacles, or pull-up receptacles

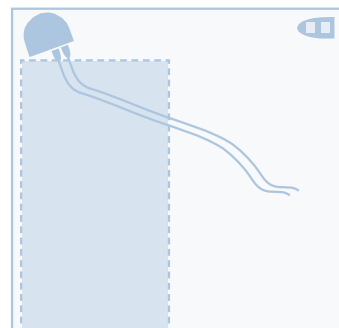

STORAGE ACCESSORIES

Consult the HON List Pricer for details on:

- CD organizers, laminate tops, spacers, glide kits, caster packages and more

Desking Shells

Desking Shells offer the benefits of a traditional freestanding desk – but with much more flexibility. You can combine shells in a wide variety of ways to meet individual needs. Shells are easy to specify, with just one model number per unit. They are easy to install, too, with one carton per unit and pre-installed fasteners. They are priced lower than Desking Components, but keep in mind that they offer fewer configuration options. Shells are visually compatible with Initiate panel-mounted components, but they cannot be integrated with panels.

Desk Shell

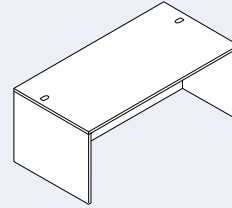

Desking shells cannot be mixed with desking components due to dimension issues.

WIDTH
72", 66", 60", 48"

DEPTH
36", 30", 24"

HEIGHT
29½"

Return Shell

- Non-handed for increased flexibility

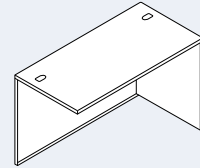

WIDTH
72", 60", 48", 42", 36"

DEPTH
24"

HEIGHT
29½"

Bridge

- Must be connected to a desk; not to be used freestanding

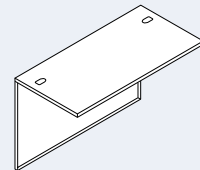

WIDTH
48", 42", 36"

DEPTH
24"

HEIGHT
29½"

Corner Shell

- Must be connected to a desk; not to be used freestanding

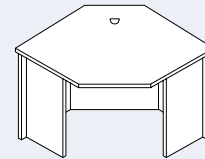

24" x 42" x 24" x 29½"H
24" x 36" x 24" x 29½"H

Desking Shells feature a top-over-panel PVC edge

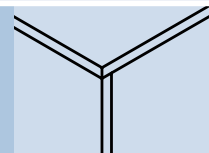

Peninsula with End Panel

- Use to create “L” configuration with a return
- OR
- “U” configuration with a bridge and credenza, desk or corner unit
- Not to be used freestanding

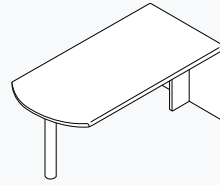

72"W x 30"D x 29½"H

Peninsula

- Use to create “L” configuration with a return
- Not to be used freestanding

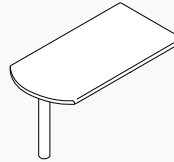

58"W x 30"D x 29½"H

Finish specifying desk shells by choosing the modesty panel that meets your needs:

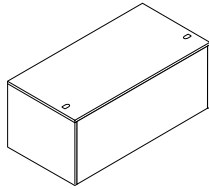

F
Full Modesty Panel
for privacy

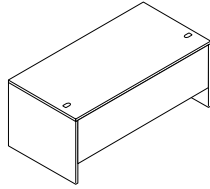

G
¾ Modesty Panel
to balance privacy
and electrical access

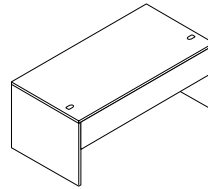

H
½ Modesty Panel
for access to wall receptacles

Desking shells
are compatible
with all
HON Pedestals.

Recommended Pedestal Options with Desking Shells

Initiate Desking Shells	36" Deep Desk			30" Deep Desk			24" Deep Desk		
	Ability to attach	Ability to use wire port	Ability to attach hutch	Ability to attach	Ability to use wire port	Ability to attach hutch	Ability to attach	Ability to use wire port	Ability to attach hutch
19 ⁷ / ₈ " D Hanging Pedestal	■	■	■	■	■	■	■		■
22 ⁷ / ₈ " D Hanging Pedestal	■	■	■	■	■	■			■
19 ⁷ / ₈ " D Freestanding or Mobile	■	■	■	■	■	■	■		■
22 ⁷ / ₈ " D Freestanding or Mobile	■	■	■	■	■	■	■		■
28 ⁷ / ₈ " D Freestanding or Mobile	■		■	■		■			

Due to wire management ports, 19⁷/₈"-deep hanging pedestals are suggested for 24" worksurface units; a deeper pedestal can be attached but it will cover the grommet cavity. If deeper hanging units are used, they will cover the wire ports and cannot be attached because the screw holes are in the cavity for the wire ports.

Full-depth floor and mobile pedestals may be used; the above chart does not consider the use of the spacer. Use of the spacer will block wire access into the knee space of the unit.

Desking Components

Desking components let you convert Initiate panel-mounted worksurfaces into freestanding desks – a terrific advantage for reconfiguration purposes. All you need to do is order the proper modesty panels and supports. (See why we say Initiate is one of the most versatile furniture systems on the market?)

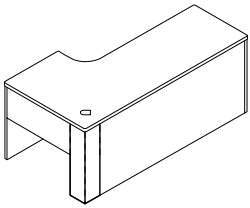

Full Modesty Panel
for privacy

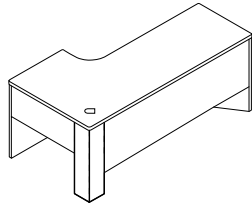

3/4 Modesty Panel
for panel baserail
access

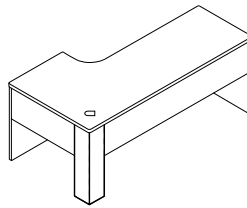

1/2 Modesty Panel
for access to electrical
receptacles when desk
is positioned against a
wall or panel



PVC

Desking Components are available with a T-Mold edge or a PVC edge.

Modesty Panel

- Required to provide structural stability on all freestanding desking components
- Specify according to the width of the worksurface you're using it with:
72", 66", 60", 54", 48", 42", 36", 30", 24"
- Each modesty panel is actually 2 1/2" narrower than its corresponding worksurface – an end panel and shared leg make up the 2 1/2" difference when installed

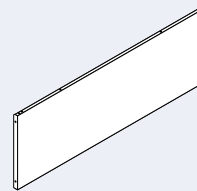

Modesty Panel



Attachment Kit

Attachment Kit

- Attaches bridge and return to desk or credenza

One of the following supports is required every 8 feet of a straight desking run:

- Full end panel
- Full leg
- Support Leg
- Freestanding pedestal attached to desk
- Lateral file attached to desk

Desk-to-Panel Connector

- Connects a worksurface and modesty panel perpendicular to a panel of equal width
- Opposing end of worksurface and modesty panel must be supported with an end-panel support or attached as a return desk from a primary desk

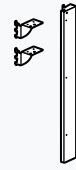

Desk-to-Panel Connector

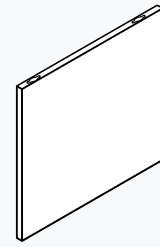

End Panel Support
DEPTH
24", 30", 36"

HEIGHT
29 1/2"

End Panel Support

- Non-handed

Support Leg

- Non-handed

"C" Leg

- Use with support leg and 30"D worksurface

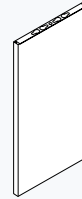

Support Leg
29 1/2"H x 14"D

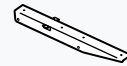

"C" Leg
20"W

Back Corner Leg

- Connects two modesty panels at the rear of a corner desk
- Measures 6" x 6"

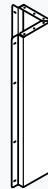

Back Corner Leg

TIP: When specifying modesty panels for use with a back corner leg, use the width of the top and subtract 6" to get required modesty panel width. See chart on page 26.

Shared Leg

- Use when joining two surfaces – instead of two support legs
- Provides 16-22" of knee clearance
- 1 1/2" radius opening for wire management

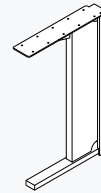

Shared Leg

Recommended Pedestal Options with Desking Components

Desking Components	30" Deep Desk			24" Deep Desk		
	Ability to attach	Ability to use wire port	Ability to attach hutch	Ability to attach	Ability to use wire port	Ability to attach hutch
19 7/8" D Hanging Pedestal	■	■	■	■		■
22 7/8" D Hanging Pedestal	■	■	■			
19 7/8" D Freestanding or Mobile	■	■	■	■		■
22 7/8" D Freestanding or Mobile	■	■	■			■
28 7/8" D Freestanding or Mobile			■			■

Back Corner Leg/Modesty Panel Sizes

Corner Worksurfaces		
Worksurface Width	Subtract 6" for Model NDBCL1	Use with Panel Width
36"W	→	30"W
42"W	→	36"W
48"W	→	42"W

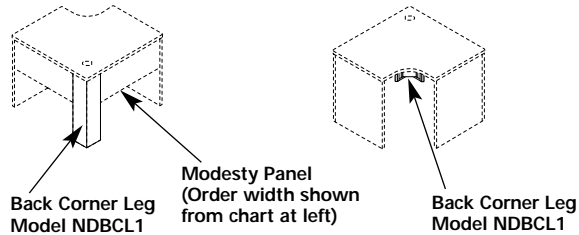

NOTE: Cannot be used as a freestanding unit

Corner Cove Worksurfaces		
Worksurface Width	Subtract 6" for Model NDBCL1	Use with Panel Width
36"W	→	30"W
42"W	→	36"W
48"W	→	42"W
60"W	→	54"W
72"W	→	66"W

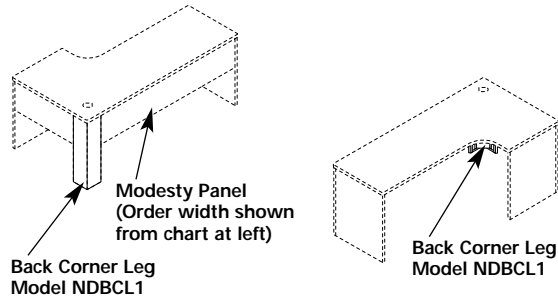

NOTE: Cannot be used as a freestanding unit

Specifying Desking Components with Panels

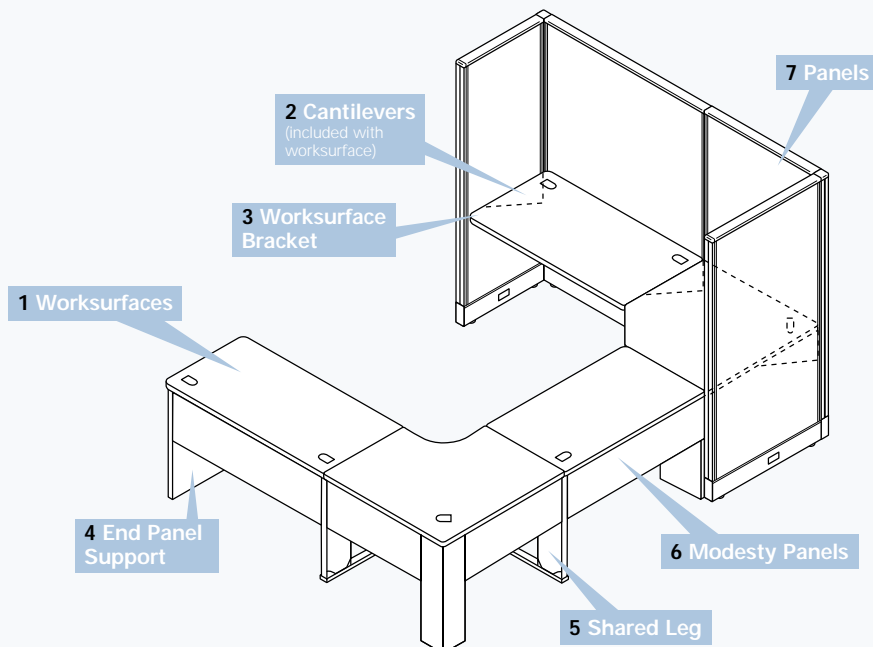

Specify to Win

Initiate delivers a lot of bang for the buck – go ahead and compare its cost-value ratio to any other system on the market. If budgets are really tight, a little careful planning can help you realize even more cost-savings.

Mix Raceway and Cableway Panels

Use cableway panels as return panels off a run of raceway panels.

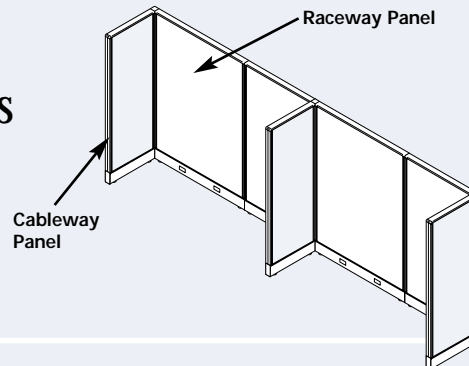

Go Wide

Wider panels are more cost-effective. For example, you'll save money by using one 60" panel rather than two 30" panels. The trade-off is fewer electrical and data receptacles, and decreased reconfiguration flexibility. Wider overhead storage cabinets and shelves are also more affordable.

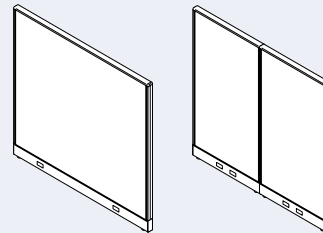

Get Sleek

Sleek is a HON panel system that combines high style with an even lower price tag than Initiate. Sleek utilizes a 1"-wide panel (as opposed to Initiate's 2" panel). Sleek panels can be used as return panels for Initiate panel runs. All you need is a simple Sleek-to-Initiate panel connector.

For more details on combining Sleek and Initiate, see Sleek Pricer information.

Other Ideas for a Winning Bid

Instead of:	Choose:
Tackable Acoustical Panels	Non-tackable Panels
Return Panels	End Panel Worksurface Legs, Pedestals or Lateral Support
PVC Edge	T-mold Edge
Fabric Codes IV, M1 & M2	Fabric Price Codes II & III
Corner Worksurface & Return	Corner Cove Worksurface
Overhead Storage Cabinets	Overhead Shelves
Samba® Keyboard Platform	HKB700 and HKB200 Keyboard Platforms
Electrical Power Harnesses	Pass-thru Cables (where possible)

Idea Starters

Seating, lighting, tackboards and paper management accessories not included in product lists.

Manager's Office

QTY	PRODUCT #	DESCRIPTION
2	NR6830Q	Raceway Top Tier Glass 68H x 30W
5	NR6836F	Raceway Fabric Panel 68H x 36W
2	NR6848F	Raceway Fabric Panel 68H x 48W
1	NR6860F	Raceway Fabric Panel 68H x 60W
4	NRC68	Universal Connector 68H
2	NEP2429	Full End Panel 24D x 29H
2	NDS6836	Sliding Privacy Screen
1	NREC	Baseraill End Cover
1	NWC3624P	Curved Corner Worksurface 36W x 24D
1	NWR2460P	Rectangular Worksurface 24D x 60W
1	NWR2448P	Rectangular Worksurface 24D x 48W
1	NCS3636P	Corner Shelf 36W x 36W x 12D
1	NPMBSW60	Paper Management Support Bar 60W
1	ST18830LR	Flagship Personal Storage Tower
1	18820R	Flagship Pedestal "R" Pull F/F 20D
1	HMST10	Scuttlebud® Mobile Table

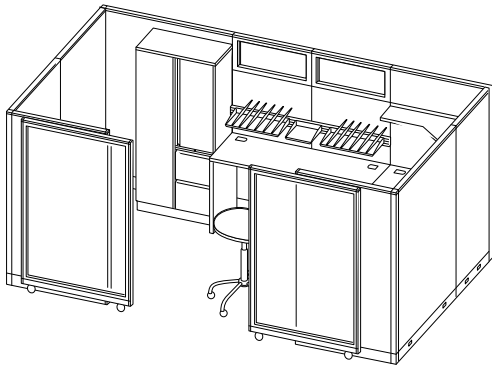

Sliding privacy screens allow closed-door conferences when needed. Personal storage tower provides maximum storage in minimum space.

Manager's Office w/Conference Area

QTY	PRODUCT #	DESCRIPTION
1	NR6836F	Raceway Fabric Panel 68H x 36W
3	NR5536S	Raceway Top Tier Perf 55H x 36W
3	NR5548S	Raceway Top Tier Perf 55H x 48W
1	NR6842S	Raceway Top Tier Perf 68H x 42W
2	NR5524S	Raceway Top Tier Perf 55H x 24W
1	NR6848S	Raceway Top Tier Perf 68H x 48W
1	NRC68	Universal Connector 68H
4	NRC55	Universal Connector 55H
3	NREC	Baseraill End Cover
1	NDS6836	Sliding Privacy Screen
1	NPMBSW42	Paper Management Support Bar 42W
1	NWR2442P	Rectangular Worksurface 24D x 42W
1	NWV93AALP	72W x 36W x 24D Left Corner Cove
1	NWSB2	Worksurface Bracket Kit
1	TCD42V	Tercero® Round Top 42" dia
1	BTR04	Tercero Leg Base for Round Tops

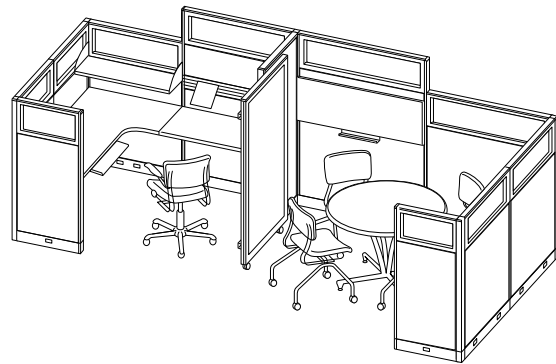

Sliding privacy panel provides an innovative solution to a manager's need for both task-oriented and team-oriented space.

Reception Station

QTY	PRODUCT #	DESCRIPTION
8	NR4236R	Raceway Top Tier Frosted 42H x 36W
2	NR5524F	Raceway Fabric Panel 55H x 24W
2	NR6836F	Raceway Fabric Panel 68H x 36W
2	NR6836R	Raceway Top Tier Frosted 68H x 36W
2	NRC42	Universal Connector 42H
2	NRC68	Universal Connector 68H
2	NREC	Baseraill End Cover
2	NCLG29	Universal Support Leg
1	NCS1572T	Countertop 15D x 72W
2	NEP2429	Full End Panel
1	NWR2472T	Worksurface Rectangular 24D x 72W
1	NWV93AALT	72W x 36W x 24D Left Corner Cove
1	NWV93AART	72W x 36W x 24D Right Corner Cove
4	9183A	Flagship 3-Drawer "A" Pull Lateral 36W
4	919436	Laminate Top for Lateral 36W

More than a reception station, it's a central information hub - with raceway panels for technology support, lateral files for storage, and lots of work-surface space for office machines.

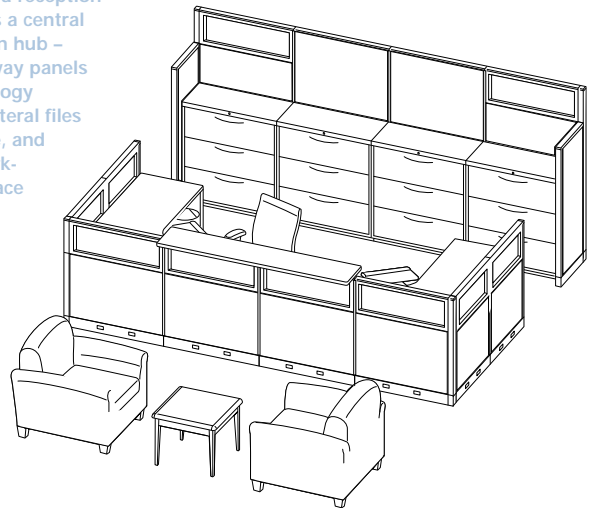

Private Office

QTY	PRODUCT #	DESCRIPTION
1	NR8136D	Raceway Double Tier Glass 81H x 36W
3	NR8136H	Raceway Worksurface Ht. Glass 81H x 36W
8	NR8136Q	Raceway Top Tier Glass 81H x 36W
2	NR8136T	Raceway Triple Tier Glass 81H x 36W
1	NR8142Q	Raceway Top Tier Glass 81H x 42W
1	ND8142	Door
1	N899910	Door Handle - Lever w/lock set
4	NRC81	Universal Connector 81H
1	NEP2429	Full End Panel
1	NWP3672P	Peninsula 36D x 72W
1	NCNLEG29	Support Column
1	NWR2436P	Rectangular Worksurface 24D x 36W
1	H831124	Flat Bracket
1	NWV93AALP	72W x 36W x 24D Left Corner Cove
2	NSC36DL	Overhead Storage Cabinet 36W
1	885LS	800 Series Lateral with Storage 36W
1	FC18730LR	Flagship Personal File "R" Pull
1	HMST01	Provisions® Table - Orange Slice

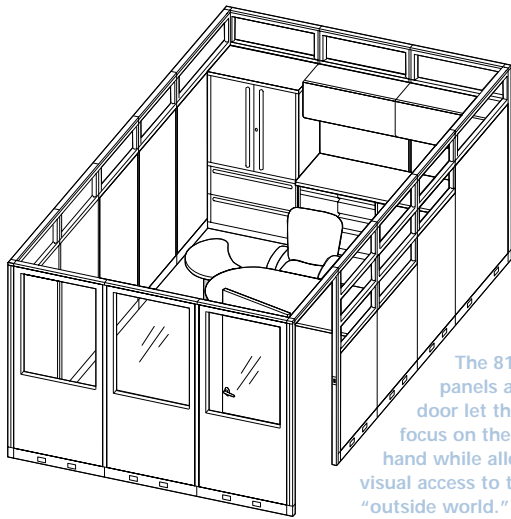

The 81"-high panels and locking door let the occupant focus on the task at hand while allowing visual access to the "outside world." An ideal application for a manager's office on a shop floor.

Touchdown Stations

QTY	PRODUCT #	DESCRIPTION
1	NR5548Q	Raceway Top Tier Glass 55H x 48W
2	NR5536Q	Raceway Top Tier Glass 55H x 36W
1	NR6824F	Raceway Fabric Panel 68H x 24W
1	NR6848F	Raceway Fabric Panel 68H x 48W
6	NR6836F	Raceway Fabric Panel 68H x 36W
4	NRC68	Universal Connector 68H
2	NREC	Baseraill End Cover
2	NECF	End Cap for Panel Top Cap
3	NOS36	Open Shelf 36W
1	NOS48	Open Shelf 48W
1	NSC36DL	Overhead Storage Cabinet 36W
2	NPMBSW36	Paper Management Support Bar 36W
4	P923A	Perpetual® Mobile Ped, "A" Pull
2	PSEAT24	Pedestal Seat
2	PTRAY	Pedestal Tray
2	PR2466A	Perpetual 24 x 66 table, Thermoform edge

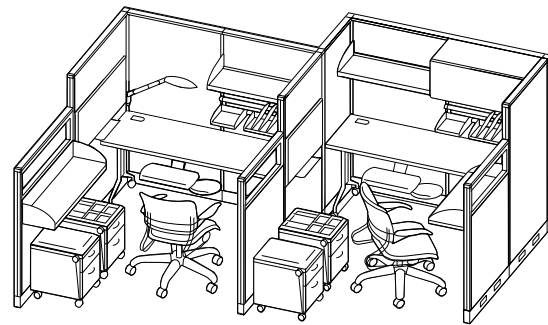

For use by location-flexible employees – e.g., salespeople who spend most of their time on the road or telecommuters who only come into the office occasionally. Touchdown stations give these employees a place to "park" and plug in their laptops when needed.

Call Center

QTY	PRODUCT #	DESCRIPTION
4	NR4248F	Raceway Fabric Panel 42H x 48W
2	NR4260F	Raceway Fabric Panel 42H x 60W
4	NR5530S	Raceway Top Tier Perf 55H x 30W
2	NRC42	Universal Connector 42H
3	NRC55	Universal Connector 55H
10	NEP2429	Full End Panel
3	NREC	Baseraill End Cover
2	NCS1548P	Countertop 48W x 15D
4	NWD2450P	D-Top 24D
4	NCNLEG29	Support Column
2	NWQ2424T	Quarter Round Worksurface 24W
2	NWR2448P	Rectangular Worksurface 24D x 48W
3	NWV75AALP	60W x 48W x 24D Left Corner Cove
3	NWV75AARP	60W x 48W x 24D Right Corner Cove
2	19723R	Flagship Pedestal "R" Pull BBF
2	9170R	Flagship 2-drawer "R" Pull Lateral 30W
1	HMST03	Provisions Table Hot Potato

This innovative layout provides abundant space for six multi-shift workers, yet occupies a relatively compact footprint.

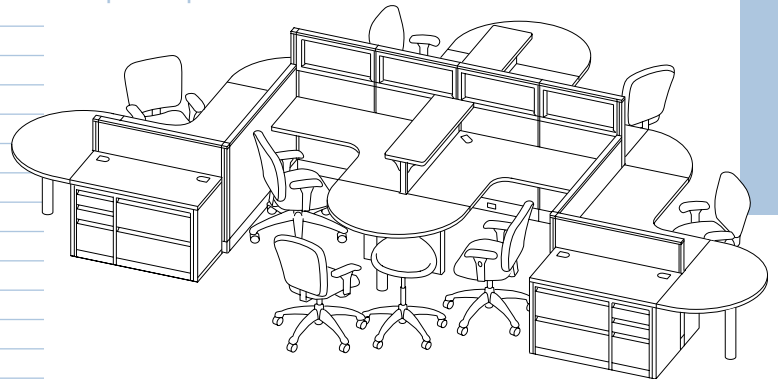

Teaming Station

QTY	PRODUCT #	DESCRIPTION
4	NR5536R	Raceway Top Tier Frosted 55H x 36W
4	NR5548R	Raceway Top Tier Frosted 55H x 48W
2	NR5524R	Raceway Top Tier Frosted 55H x 24W
2	NRC55	Universal Connector 55H
4	NDPC1	Desk-to-panel Connector
3	NREC	Baseraill End Cover
4	NDSL29	Shared Leg
4	NDEP2429	Full End Panel
4	NWCS3624P	Corner Worksurface 36W x 24D
4	NWB2	Worksurface Bracket Kit
8	NWR2448P	Rectangular Worksurface 24D x 48W
4	NDMP48H	Modesty Panel 48W
4	NDMP36H	Modesty Panel 36W
4	NOS36	Open Shelf 36W
4	P923A	Perpetual Mobile Ped, Arch Pull
4	PSEAT24	Pedestal Seat
1	BTR04	Tercero Leg Base
1	TCD48V	Tercero Round Top 48"

Designed for four people who need to focus on individual tasks while frequently collaborating on group work.

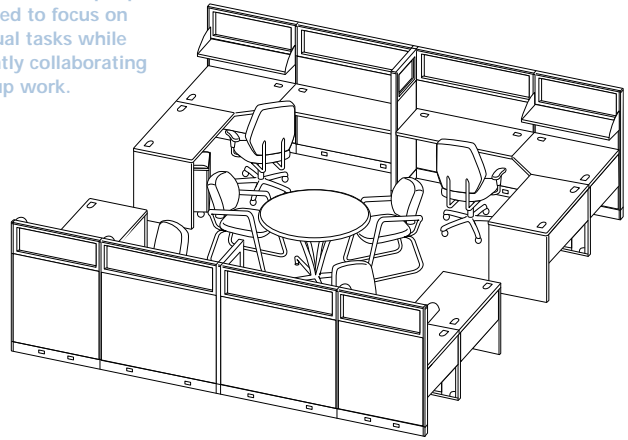

Groupwork Station

QTY	PRODUCT #	DESCRIPTION
4	NR4224F	Raceway Fabric Panel 42H x 24W
10	NR4236F	Raceway Fabric Panel 42H x 36W
8	NR5536Q	Raceway Top Tier Glass 55H x 36W
4	NR5548Q	Raceway Top Tier Glass 55H x 48W
2	NR6836F	Raceway Fabric Panel 68H x 36W
4	NR6848F	Raceway Fabric Panel 68H x 48W
4	NRC42	Universal Connector 42H
4	NRC55	Universal Connector 55H
2	NRC68	Universal Connector 68H
8	NREC	Baseraill End Cover
4	NSC48DL	Overhead Storage Cabinet 48W
2	NCNLEG29	Support Column
2	NWD2450P	D-Top 24D
4	NCLG29	Universal Support Leg
8	NWR2436P	Rectangular Worksurface 24D x 36W
4	NWV95AALP	72W x 48W x 24D Left Corner Cove
4	NWV95AARP	72W x 48W x 24D Right Corner Cove
2	NCS1536P	Countertop 36W x 15D
4	NPMBWSW36	Paper Management Tool Rail 36W
4	NPMBWSW48	Paper Management Tool Rail 48W
4	FC18730LR	Flagship File Center "R" Pull BBF 18D
8	18720R	Flagship Pedestal "R" Pull BBF 20D

Different panel heights provide varying levels of privacy while countertops and half-round worksurfaces support interaction.

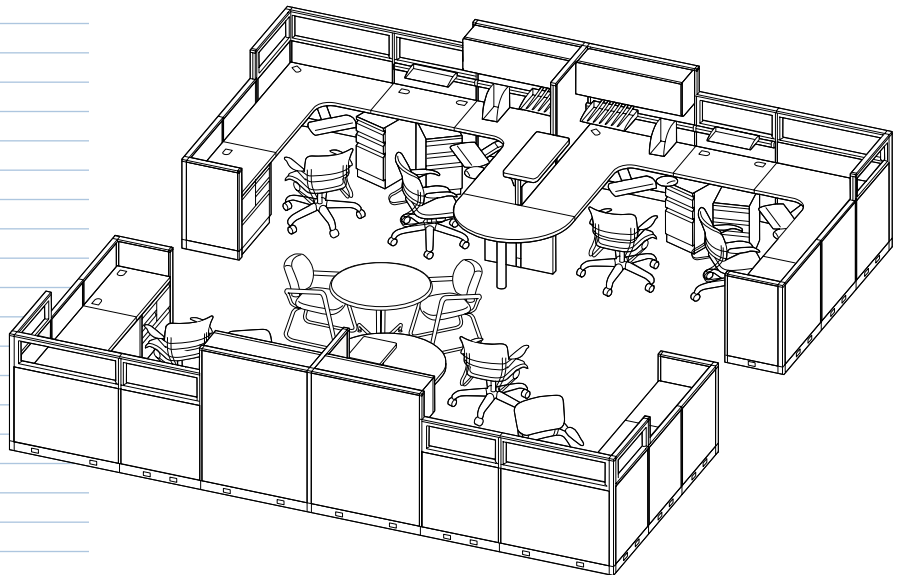

Quad Cluster

QTY	PRODUCT #	DESCRIPTION
4	NR6842Q	Raceway Top Tier Glass 68H x 42W
1	NRC68	Universal Connector 68H
2	NREC	Baseraill End Cover
4	NWC4224P	Curved Corner Worksurface 42W x 24D
4	NWD2450P	D-Top 24D
8	NCLG29	Universal Support Leg
4	NCNLEG29	Support Column
4	NCS4242P	Corner shelf 42W x 42W x 12D
4	18720R	Flagship Pedestal "R" Pull B/B/F 20D

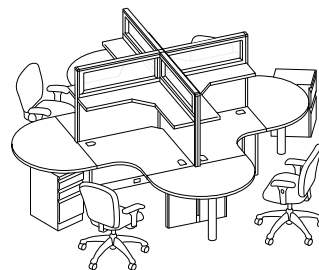

Clusters allow very efficient use of valuable space. Here, tall panels maximize privacy for four workers while half-round worksurfaces allow collaboration. Raceway panels provide technology support.

Freestanding Corner Desk with Returns

QTY	PRODUCT #	DESCRIPTION
1	NWC4824T	Corner Worksurface
2	NRW2454T	Rectangular Worksurface
1	NDBCL1	Back Corner Leg
2	NDEP2429	End Panel Support
2	NDSL29	Shared Leg
2	NDMP42F	Modesty Panel Full Height
2	NDMP54F	Modesty Panel Full Height

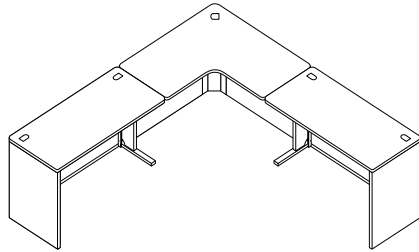

Desking Components allow you to maintain complete visual compatibility with panel system components – and offer more flexibility for reconfiguration purposes.

Freestanding U-Station

QTY	PRODUCT #	DESCRIPTION
1	NWR2442T	Rectangular Worksurface
2	NWR2460T	Rectangular Worksurface
1	NDMODKITF	Attachment Bracket Kit
1	H831124	Flat Bracket
2	NWSB2	Worksurface Bracket Kit
1	NDMP42F	Modesty Panel Full Height
1	NDMP60F	Modesty Panel Full Height
2	NDEP2429	End Panel Support
1	NDSP29	Support Leg
2	NR6824F	Raceway Fabric Panel
1	NR6860F	Raceway Fabric Panel
2	NRC68	Universal Connector
1	NREC	Raceway Panel End Cover

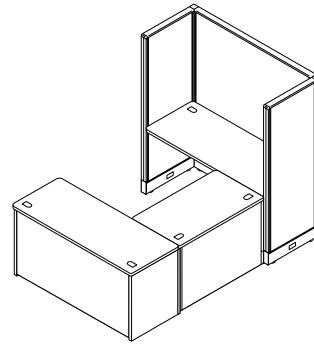

Desking Components can be combined with Initiate panels for “panel-wrapped” layouts.

Freestanding Corner Desk

QTY	PRODUCT #	DESCRIPTION
1	N8230FP	36W x 24D Bridge Full Modesty
1	N8928FP	24D x 36W x 36W Corner Full Modesty
1	N8942P	30D x 72W Peninsula w/End Panel
1	N8948FP	24D x 72W Return Full Modesty
1	38244N	Stack-on Shelf 72W
1	38249	Flipper Doors for 72W Stack-on
1	T72	20H Tackboard for 72W Stack-on
1	FC18730LR	Flagship File Cntr “R” Pull BBF

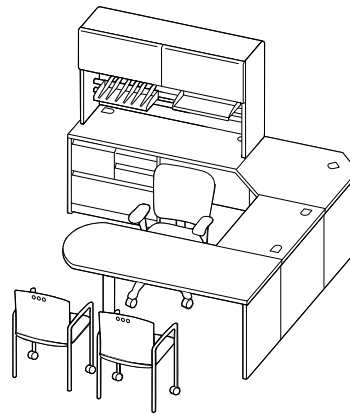

Combine Initiate Desking Shells with 38000 Series Stack-on components to create a freestanding configuration ideal for placement against architectural walls.



HON[®]

www.hon.com

© 2005 The HON Company.
HON, Initiate, Flagship, Efficiencies, Samba, Scuttlebud, Provisions and Perpetual
are registered trademarks. Sleek and Tercero are trademarks.



Printed in USA
Form No. H3005