

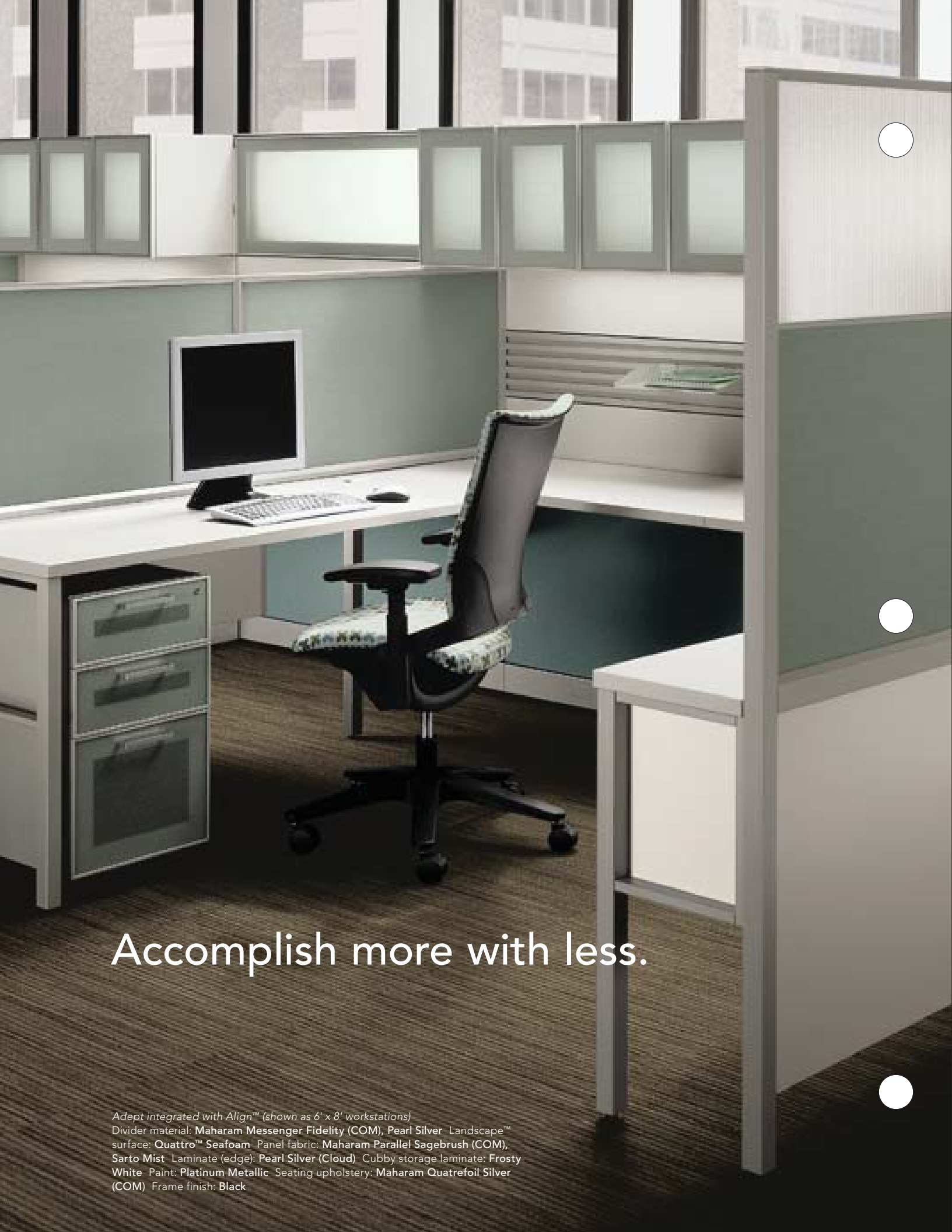

Allsteel[®]

Designed to work. Built to last.

Adept[™]



Accomplish more with less.

Adept integrated with Align™ (shown as 6' x 8' workstations)
Divider material: Maharam Messenger Fidelity (COM), Pearl Silver Landscape™
surface: Quattro™ Seafoam. Panel fabric: Maharam Parallel Sagebrush (COM),
Sarto Mist. Laminate (edge): Pearl Silver (Cloud). Cubby storage laminate: Frosty
White. Paint: Platinum Metallic. Seating upholstery: Maharam Quatrefoil Silver
(COM). Frame finish: Black.

Adept is a new and simpler way to divide space in the office.

Slender yet surprisingly strong, Adept dividers provide privacy, planning freedom, and design options, while leaving the heavy lifting of support and cabling to the spine wall. Adept works with Allsteel systems furniture, both structurally and aesthetically, and includes its own desking and storage components, making it easier than ever to plan, set up, and reconfigure work areas that get the job done.

Plan with connectors...

Place Adept at connections on the spine wall, and you can use full-height dividers as well as utilize any Allsteel worksurface, including curvilinear shapes like reefs and coves, to create an expansive workspace.

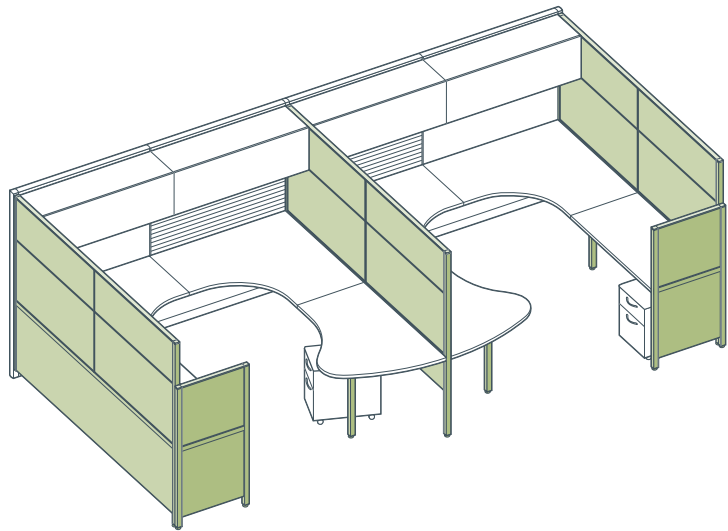

...or go off-module.

Adept desking units and supports can be located and easily moved anywhere along the spine wall to create off-module work areas of any size.

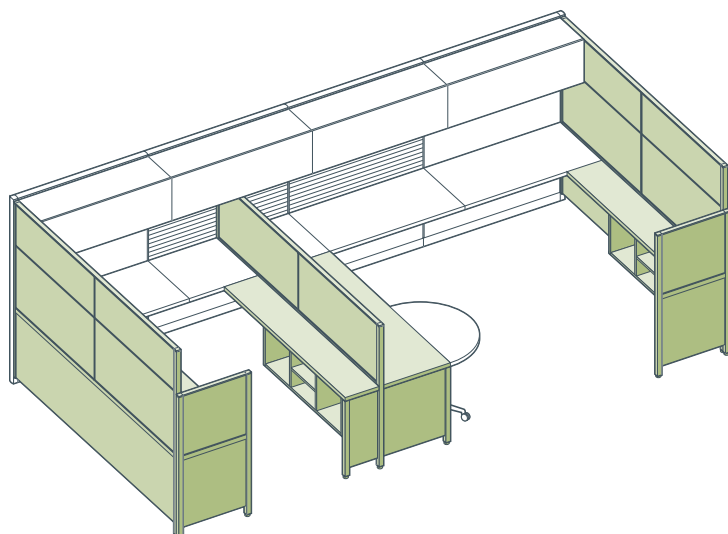

Green designates Adept dividers, desking, and storage products.

Make every place a better space.

Adept can be used throughout the office to create a fresh, light-scale attitude. Start with any Allsteel system as the spine, and use Adept dividers and components to create hoteling spaces, manager stations, and even teaming areas. Adept actually enhances systems furniture by letting each part do what it does best.



Provide more light for more productivity.

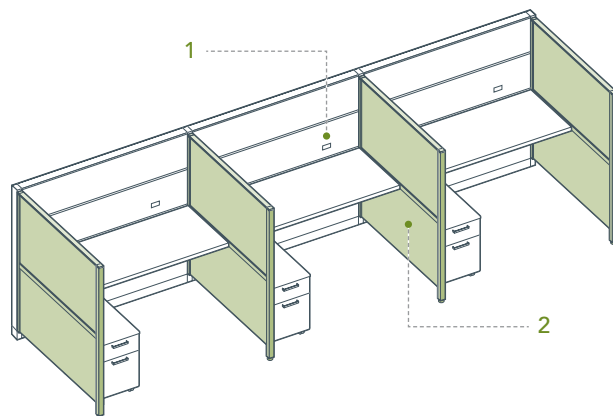

1. Terrace 3.4 in the spine brings maximum plug-in capacity right to the desktop where you need it most.
2. Dividers are translucent above to increase the flow of natural light and laminate below to ensure modesty.



Adept's quick-connection is a smart design that makes installation simple and future changes easy to manage.

Adept integrated with Terrace 3.4 (shown as 4' x 5' workstations)
 Panel fabric: Sarto Lemongrass, Tasanee Citrus Laminate (edge): Whitestone (Muslin)
 Modesty laminate: Pearl Bisque Paint: Champagne Metallic Seating upholstery:
 Chatterbox Peat, Luna Hoop Riff (COM) Frame finish: Charblack



Get all the privacy you need, in the slender scale you want.

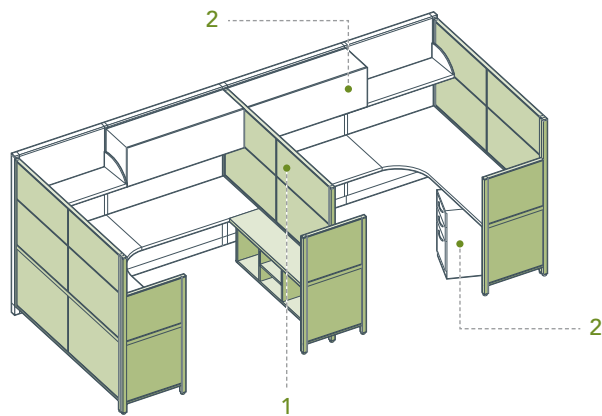

Adept cubby storage keeps reports, files, and binders in view and close at hand.

1. Full-height dividers can be segmented for design flexibility to mix textures, color, pattern, and light.
2. Integrate any Allsteel storage with Adept, from mobile pedestals to overheads, open shelves and more.

Adept integrated with Concensys® (shown as 6' x 7' workstations)
 Divider material: Fluted Translucent, Tasanee Silk, Tasanee Cumin Panel fabric:
 Tasanee Silk Laminate (edge): Whitestone (Muslin) Cubby storage laminate: Frosty
 White Paint: Muslin Seating upholstery: Open House Goose Frame finish: Black



Lower the walls to encourage and improve teamwork.

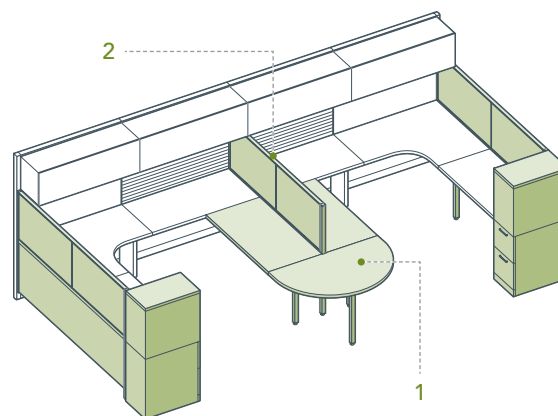

1. Shared workspaces between offices let people work back-to-back, side-by-side, or face-to-face.
2. A seated-height divider ensures privacy for activities that require concentration, while providing an opportunity for people to come together.



Adept storage towers on the ends provide worksurface support, ample storage, and efficient division of space.

Adept integrated with Terrace 2.6 (shown as 8' x 8' workstations)
 Divider material: Sarto Sisal, Pearl Bisque Panel fabric: Sarto Sesame Laminate
 (edge): Whitestone (Muslin) Paint: Champagne Metallic Seating upholstery: Terra
 Wheat Frame finish: Charblack



Show some flexibility.

Adept's off-module planning option, along with non-handed and reversible components, let you change office configurations without disturbing the spine wall. Desking units can be moved along the spine and offices finished with storage, worksurface supports, or dividers at the ends. When your headcount changes, it's easy to change your office count, too.

Adept integrated with Align (shown as 6' x 6' workstations)

Divider material: Maharam Messenger Fidelity (COM), Pearl Silver Landscape surface: Quattro Seafoam Panel fabric: Maharam Parallel Sagebrush (COM), Sarto Mist Laminate (edge): Pearl Silver (Cloud) Cubby storage laminate: Frosty White Paint: Platinum Metallic Seating upholstery: Maharam Quatrefoil Silver (COM) Frame finish: Black



There's no need to disrupt the spine to accommodate more staff. Simply slide Adept desking units into new positions, add another desking unit and overhead storage cabinet...

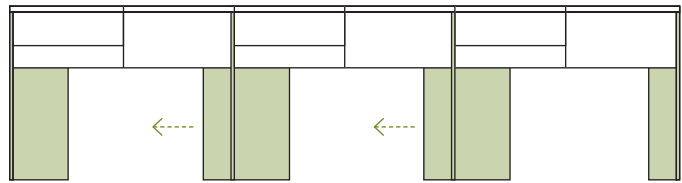

...and three offices become four. Moves, adds, and changes are simpler to manage.

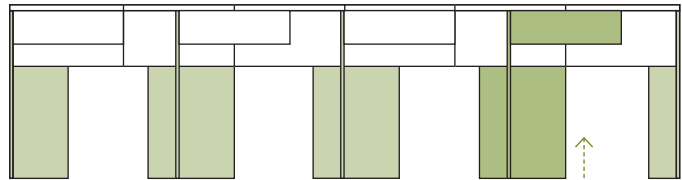



Use Reach as the spine and get more efficient storage in a smaller footprint.



Half-height modesty panels provide privacy below the worksurface, while keeping the feeling modern and open.

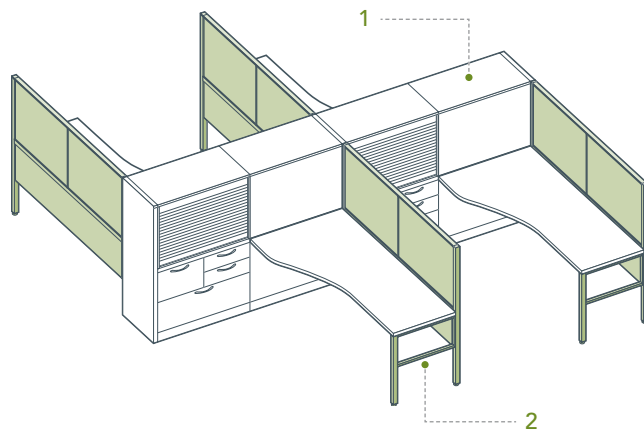

1. Maximize your storage, minimize your footprint, and keep the feeling light and airy with a space-efficient Reach storage wall as the spine.
2. Slender worksurface supports and dividers make offices and people more accessible.

Adept integrated with Reach™ (shown as 6' x 6' workstations)
 Divider material: Luna Odeon Bibolet (COM), Pearl Bisque Panel fabric: Luna Odeon Bibolet (COM) Laminate (edge): Whitestone (Muslin) Paint: Champagne Metallic Seating upholstery: Maharam Precisely Brick (COM) Frame finish: Black



Open the office to more texture, color, finishes, and collaboration.

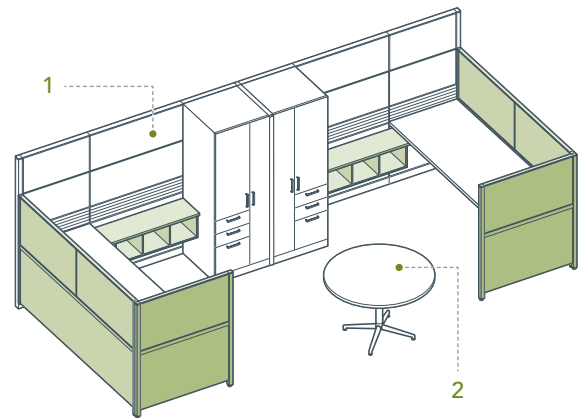

Align in the spine and Adept cubby storage create a custom look while maximizing storage opportunities.

1. All fabrics, finishes, and materials can easily be coordinated between Adept and every other Allsteel system.
2. Use Merge™ tables to turn any space into conference space.

Adept integrated with Align (shown as 7' x 8' workstations)
 Divider material: Fluted Translucent, Maharam Medium Pumpkin, Pearl Bisque
 Landscape surface: Foundation™ Sand Panel fabric: Maharam Medium Pumpkin, Maharam Oracle Mollusk (COM) Cleargrain™ veneer: Burnished Cherry Cubby storage laminate: Frosty White Paint: Champagne Metallic Seating upholstery: Brisa® Cinnabar (COM), Marquee Penny Frame finish: Aluma, Charblack

Plan your Adept offices at panel connections...

- Modular planning lets you organize offices at pre-determined panel widths.
- For extra privacy, utilize full-height dividers connected to the spine wall.
- Use laminate or fabric modesty panels.
- Integrate most any Allsteel worksurface, including curvilinear shapes.

...or with off-modular desking units.

- Create offices of any size, using desking units anywhere along the spine.
- Make moves, adds, and changes without disrupting the spine wall.
- No connectors mean no dimension is added to the spine wall.
- Simplify inventory management.



With desk-based Adept, you can position desking units in alignment with overhead storage.



Off-modular desking allows you to set up offices of any size, not just where panels connect.



Adept coordinates with Allsteel storage components. All finishes and pulls are complementary for complete aesthetic cohesion.

Setting up your Adept office.

Planning and using Adept with an Allsteel system for the spine wall is extremely simple, as detailed in the step-by-step instructions below.

Panel-connected

Step 1.

Choose any Allsteel panel system or Reach integrated storage for a spine wall.



Step 2.

Position Adept dividers at panel connections.

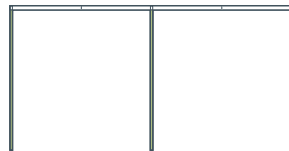

Step 3.

Utilize worksurfaces from the system offering.

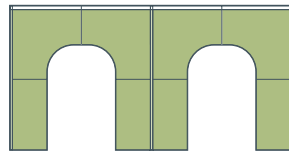

Step 4.

Finish ends with Adept storage, worksurface supports, or end dividers.

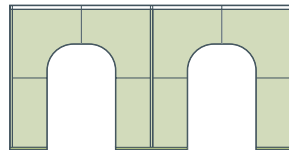

Step 5.

Add cubby storage and storage from the Allsteel standard offering.

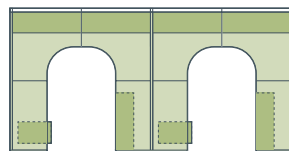

Desk-based

Step 1.

Choose any Allsteel panel system for a spine wall. Add worksurfaces.



Step 2.

Position Adept dividers and worksurfaces along outside walls.

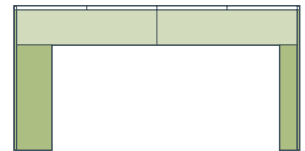

Step 3.

Place Adept desking kit, including divider, worksurface, and support.

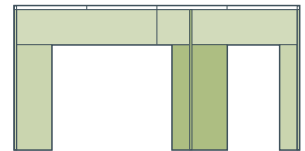

Step 4.

Finish ends with Adept storage, worksurface supports, or end dividers.

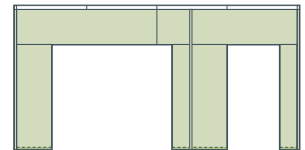

Step 5.

Add cubby storage and storage from the Allsteel standard offering.

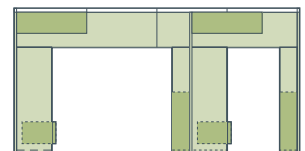

Adept

Statement of Line

Allsteel Spine Wall Options

Align



Terrace 3.4



Terrace 2.6



Concensys



Reach

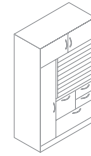

Panel-Connected Dividers

Standing-Height

Segmented
(all fabric or fabric lower/
translucent upper)



Monolithic
(fabric or translucent)

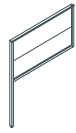

Seated-Height

Monolithic
(fabric or translucent)



Desking Kits

Single-Sided

(24" deep worksurface;
fabric or translucent
desk divider)

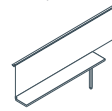

Dual-Sided

(12"/12", 12"/24", or
24"/24" deep worksurface;
fabric or translucent
desk divider)

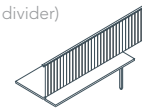

Divider heights (nominal): 68", 52" (Align); 69", 56", 53" (Terrace); 69", 53" (Concensys); 69", 56" (Reach). Divider widths: 48", 54", 60", 66", 72", 78", 84", 90", 96".

Worksurface widths: 36", 42", 48", 54", 60", 66", 72".
Desking kits include worksurface, divider, and post leg.

Full-Height Modesty Panels

(for use with
panel-connected
dividers and
desking kits;
laminite
or fabric)

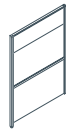

Half-Height Modesty Panels

(for use with
panel-connected
dividers and
desking kits;
laminite only)

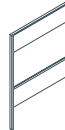

Modesty panel widths: 48", 54", 60", 66", 72", 78", 84", 90", 96" (panel-connected). 36", 42", 48", 54", 60", 66", 72" (desk-based; laminite only).

Adept Worksurfaces

Secondary

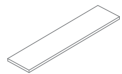

D-Shaped



Allsteel Standard Worksurfaces

Primary

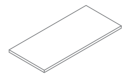

Corner

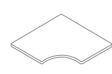

Corner Cove

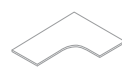

Reef



Peninsula



Most Allsteel standard worksurfaces can be used with Adept.

End caps



Choose an end cap option based on workstyle, privacy needs, and office aesthetics.
(from left to right: open end panel, closed end panel, end divider, storage tower)

End Caps

Standing-Height End Dividers

Segmented
(all fabric or
fabric lower/
translucent
upper)



Seated-Height End Dividers

Monolithic
(fabric or
translucent)



Full-Height Modesty Panels

(for use with
end dividers;
laminated
or fabric)



Half-Height Modesty Panels

(for use with
end dividers;
laminated only)



End dividers available in same heights as dividers.
Standing-height end divider widths: 25½", 31½", 37½", 43½", 49½".
Seated-height end divider widths: 25½", 31½", 37½", 43½", 49½",
61½", 73½", 85½", 97½".

Modesty panels available in same widths as end dividers.

Standing-Height Storage Towers

Box/Box/File File/File

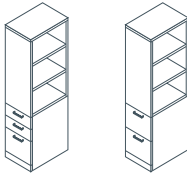

Seated-Height Storage Towers

Box/Box/File File/File

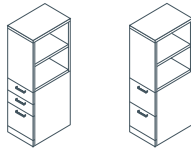

Open End Panel



Closed End Panel



Storage towers available in same heights as dividers.
Storage tower width: 15". Open shelves available on the left or right. Laminated top standard on seated-height storage towers.

End panel depths: 12", 24", 30".

Cubby Storage

13"H x 40"W x 11"D
(shown mounted
beneath 12" deep
worksurface)

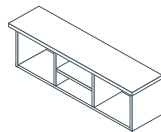

Overhead cabinets, shelves, and mobile pedestals from Allsteel's storage offering complete your Adept office.



With non-handed end dividers, no additional connectors or parts are required to reconfigure offices. It's just one more way Adept saves you time and money.



Adept

Adept dividers, desking, and storage provide a light-scale solution for individual and collaborative work areas. Designed to be used with any Allsteel panel system or Reach integrated storage, Adept quickly installs on- or off-module with matching or contrasting fabrics and surface finishes. Adept creates a fresh, modern aesthetic whether used as part of a new specification or to update existing systems furniture. It's all part of Allsteel's commitment to ongoing workspace innovation that offers increased functionality as well as design and planning freedom.



For more information, please visit allsteeloffice.com.

Respecting the environment.

At Allsteel, we help our business partners achieve a positive environmental impact and understand that environmental stewardship benefits us all. We ensure that all materials balance performance and sustainability. Relevant, durable, high-quality products guarantee years of use and re-use.

Allsteel®

Designed to work. Built to last.

Allsteel Inc.
Muscatine, Iowa 52761-5257
allsteeloffice.com

©2007 Allsteel Inc.
Allsteel, Concensys and Terrace are registered trademarks and Adept, Align, Cleargrain, Designed to work. Built to last., Foundation, Landscape, Merge and Reach are trademarks. Brisa is a registered trademark. Quattro is a trademark of 3 Form.

Product meets or exceeds ANSI/BIFMA performance standards for business and institutional furniture, and is backed by the Allsteel Lifetime Warranty.

